

## *Park and Trail Plan*

*Adopted 2005 / Updated 2013*



*Prepared by:*



Northwest Associated Consultants, Inc.

# Table of Contents

Acknowledgements .....	1
Introduction .....	3
Park and Trail Issues .....	5
Park and Trail Inventory .....	13
Parks and Recreation Policies .....	21
Plan Development .....	29
Implementation .....	41
Facility Design Standards .....	51
Park Dedication Analysis .....	55
List of Figures:	
Figure P-1: Park System .....	9
Figure P-2: Park Search Areas .....	11
Figure P-3: Trail System .....	37
Figure P-4: Park and Trail System Plan .....	39

**Appendix A** – Park Templates

**Appendix B** – Recreational Facility Standards

**Appendix C** – Parks Capital Improvement Plan



## **Acknowledgements**

The following are the individuals who contributed their time and comments, which made this Park and Trail System Plan possible:

### *Community Representatives*

#### 2005 Park & Trail Plan

##### **City Council Members:**

Mayor Randy Dressen, Tim Brown, Ray Jones, Kerry Schoer, Steve Kane

##### **Park Commissioners:**

Chairman Chad Solei, Bryan Glynn, Jim Nye, Deanna Carlson,  
Rob Johnson, Leroy Schaffer, Jeff Sandoval

##### **City Staff:**

Jim Lacey, Streets/Parks Superintendent

#### 2013 Park & Trail Plan Amendments

##### **City Council Members:**

Mayor Jerry Tveit, Tim Brown, Mike Haggard, Amy Lazere, Chris McClish

##### **Planning Commissioners:**

Chairman Rich Skordahl, Todd Gardner, William Murray,  
Joel Olson, Roni Ronyak, Ray Steinke, Greg Zutz

##### **City Staff:**

Paul Teicher, Public Works Director



## Introduction

Continuing development pressures within the City of St. Francis have prompted a need to address the recreational needs of not only its present population, but future population growth as well. The City has adequate parkland and facilities currently, but recognizes that continued growth will increase the demand for park and trail amenities. The residents of the City have placed a high priority for development of existing parks in the community and recognize that demand will only increase as the population increases and residents grow older. St. Francis has the advantage of being in a position to plan and provide for such community facilities in advance of the demand.

The intent of this Park and Trail System Plan is to further the directive of the Comprehensive Plan in regard to planning for and providing active and passive recreational opportunities for community residents. Specifically, this plan is intended to provide analysis and a subsequent decision-making framework to guide City officials in providing community services and facilities, as well as addressing private development proposals. It includes an inventory of current facilities, needs assessment, goals, and policies. This plan will likely need revisions over time as the basic planning assumptions, implementation strategies, and goals are no longer considered valid, or when the City population and recreational demands warrant amendment. Revision should be considered on a regular basis to keep the plan current with community philosophy and user characteristics.

This plan was originally adopted in December 2005. After adoption of the City's updated Comprehensive Plan, the Park Plan was reviewed by the Planning Commission in 2012. Amendments to the Plan were adopted by the City Council on March 18, 2013 by Resolution No. 2013-05.



## Park and Trail Issues

The initial phase of the Parks and Trails Plan involves identifying issues related to community park and trail development. Such issues may then be used to formulate policies that reflect the park and trail system the City wishes to achieve.

*Based upon discussions and information received from the public during various “open house” meeting events, the following were identified as primary issues confronting St. Francis in regard to park and trail development.*

- The City should investigate alternative funding sources for facility improvements beyond standard park dedication fees.
- The City needs to establish a set of priorities in regard to park and trail development.
- The City is lacking in active recreational facilities/programs and relies heavily on adjacent communities for such opportunities.
- The recreational needs of all population groups needs to be considered in the City’s park and trail planning efforts.
- Community promotion of park and trail facility use is important in establishing a community identity.
- Development of additional picnic and playground facilities, tennis courts, hockey rinks, skate parks, and soccer fields are all seen as important to St. Francis residents.
- Continued physical improvements to existing park sites are of importance in order to serve the recreational demands of community residents.
- Development of a trail system to connect neighborhoods to recreational areas and commercial centers is seen as a priority for the City.
- Trail systems should be developed to serve all modes of potential recreational trail utilization.
- Cooperation with Anoka County and surrounding jurisdictions in regard to park and trail planning is considered beneficial.
- The Park and Recreation Commission, Planning Commission, and City Council must maintain an active working relationship.





## Park and Trail Inventory

*Park and recreational facilities may serve as a major tool in promoting community identity for St. Francis. The recreational needs of St. Francis will continue to grow as the population increases.*

The first step in determining the needs of the recreational system is the identification of the existing conditions. A park inventory should be developed and periodically updated to provide a base line reference for any park and trail system.

### Population & Future Park Planning

The tables below show population projections for the City of St. Francis as included in the most recent Metropolitan Council 2040 forecasts. Currently, the City of St. Francis is estimated to have approximately 7,296 residents, approaching the population forecast for 2020 of 8,200 people as estimated by the Metropolitan Council. The Metropolitan Council forecasts the City will grow to 10,400 people by 2030 and 12,600 by 2040.

The City's park needs will be based on the population estimates as calculated by the Met Council and the adopted Park and Trail System Plan will be revisited and updated as necessary to reflect the most current population growth estimates.

CITY OF ST. FRANCIS			
YEAR	POPULATION	HOUSEHOLDS	PEOPLE/HH
1990	2,538	760	3.34
2000	4,910	1,638	2.99
2010	7,218	2,520	2.86
2020	8,200	3,100	2.65
2030	10,400	4,100	2.53
2040	12,600	5,100	2.47

*Source: 2010 US Census, Metropolitan Council*

Data compiled by the Metropolitan Council indicates that the population of St. Francis is anticipated to grow to 12,600 by the year 2040. For park planning purposes, the National Recreation and Park Association (NRPA) suggests a range of 6.25 to 10.5 acres of land per 1,000 people. For the purposes of this analysis we will use the figure of 10 acres of park land per 1,000 people. This figure encompasses all types of park land, passive and active, ranging from mini parks to large scale community parks. Utilizing the population forecast set forth above, St. Francis can anticipate the need for park acreage as follows:

## Park and Trail Inventory

---







CITY OF ST. FRANCIS		
YEAR	ESTIMATED POPULATION	REQUIRED PARK ACREAGE (10 acres / 1,000 people)
1990	2,538	25.4 acres
2000	4,910	49.1 acres
2010	7,218	72.0 acres
2020	8,200	82.0 acres
2030	10,400	104.0 acres
2040	12,600	126.0 acres

Based upon the foregoing, the City of St. Francis park system should currently include approximately 72 acres of parkland to serve the 2010 population. Approximately 130 acres of parkland will eventually be required to accommodate the anticipated 2030 population of 12,800 residents. Planning and implementing a park system require consideration of numerous factors including, but not limited to, open space areas, land cover and high quality habitat.

# Park System

## Figure P-1

### Parks

-  Community Park
-  County Park
-  Neighborhood Park
-  School District Properties
-  State Wildlife Mgt. Areas
-  Open Space

 Rivers & Streams

 Protected Waters

 City Boundary



0 0.25 0.5 1 Miles



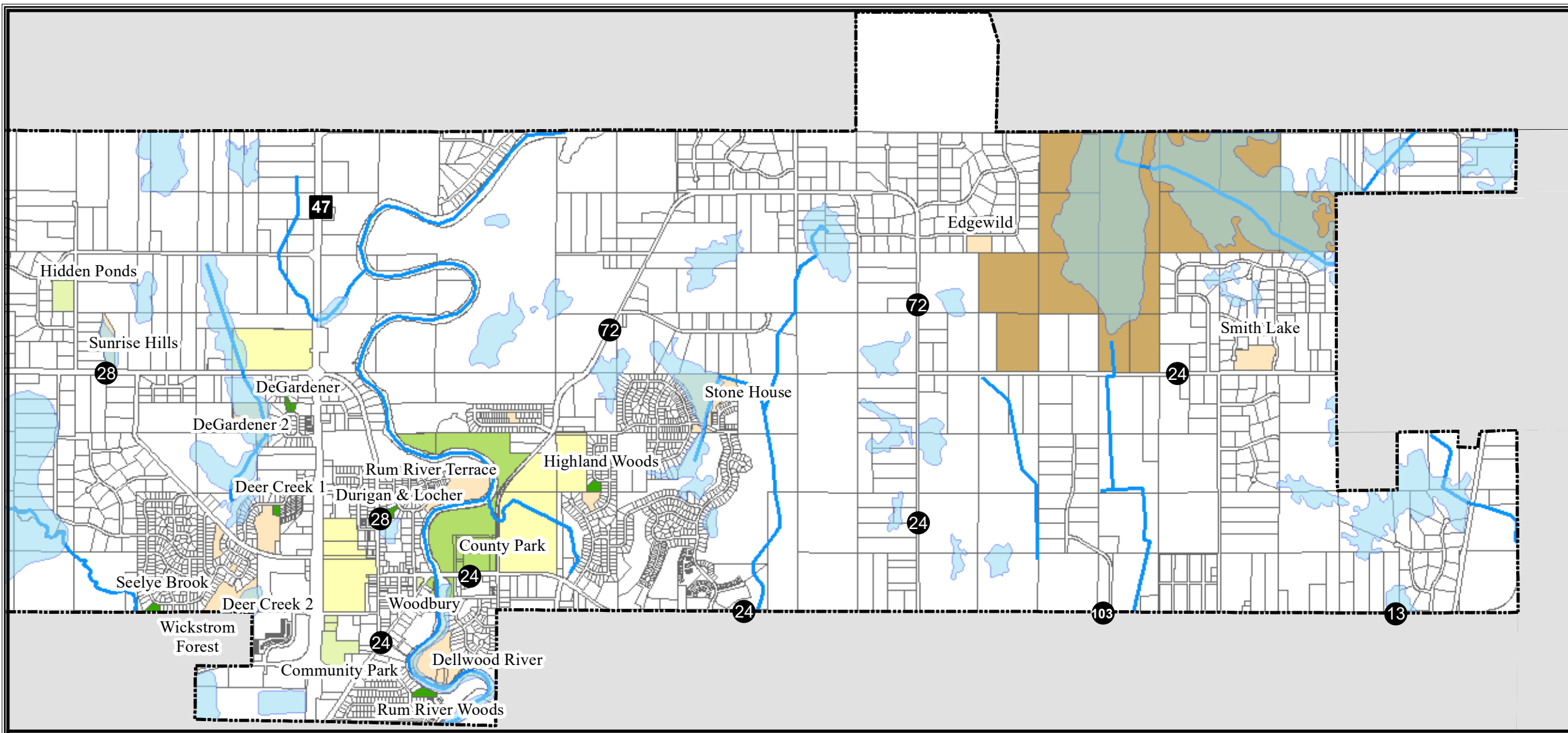
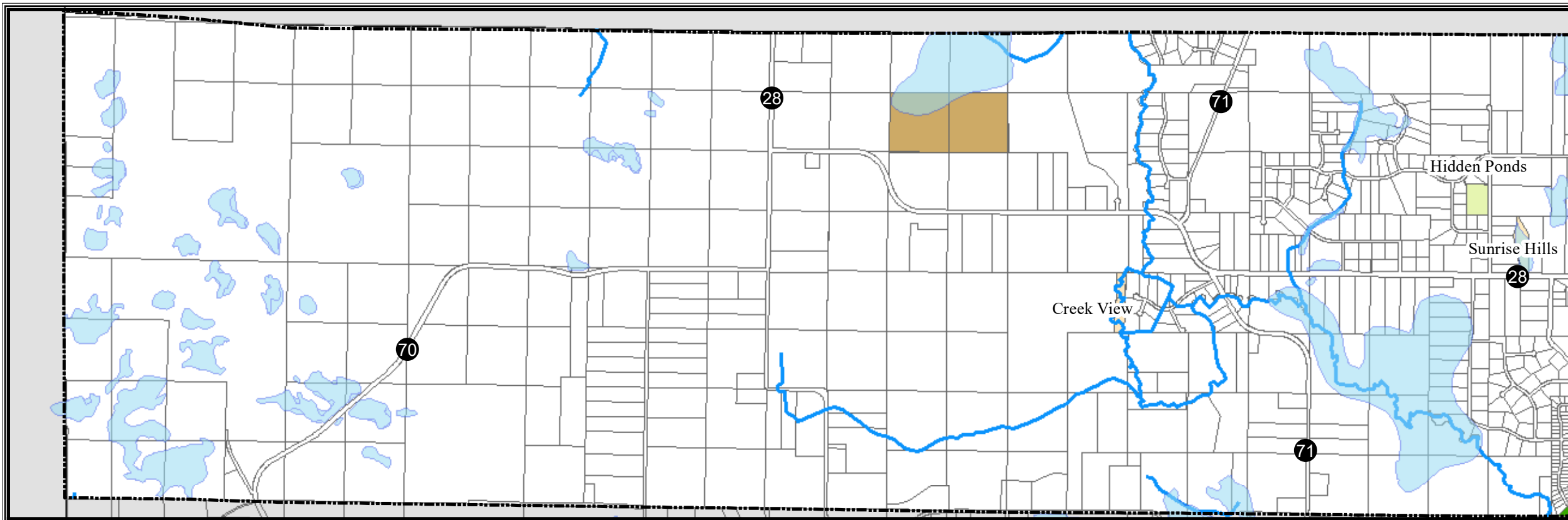



Source: Anoka County GIS; MN DNR; Bolton and Menk, Inc; Northwest Associated Consultants  
August 2016





Park Search Areas  
Figure P-2

**Parks**

-  Community Park
-  Neighborhood Park
-  Open Space
-  County Park
-  School District Properties
-  State Wildlife Mgmt. Areas

 Rivers & Streams

 Protected Waters

 City Boundary

 Future Neighborhood Park Search Areas

 Future Community Park Search Areas

 Future Regional Park Search Areas

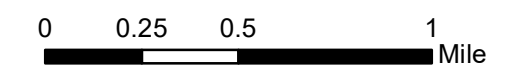
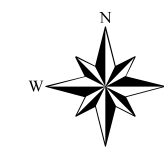

Source: Anoka County GIS; MN DNR; Bolton and Menk, Inc; Northwest Associated Consultants  
April 2015

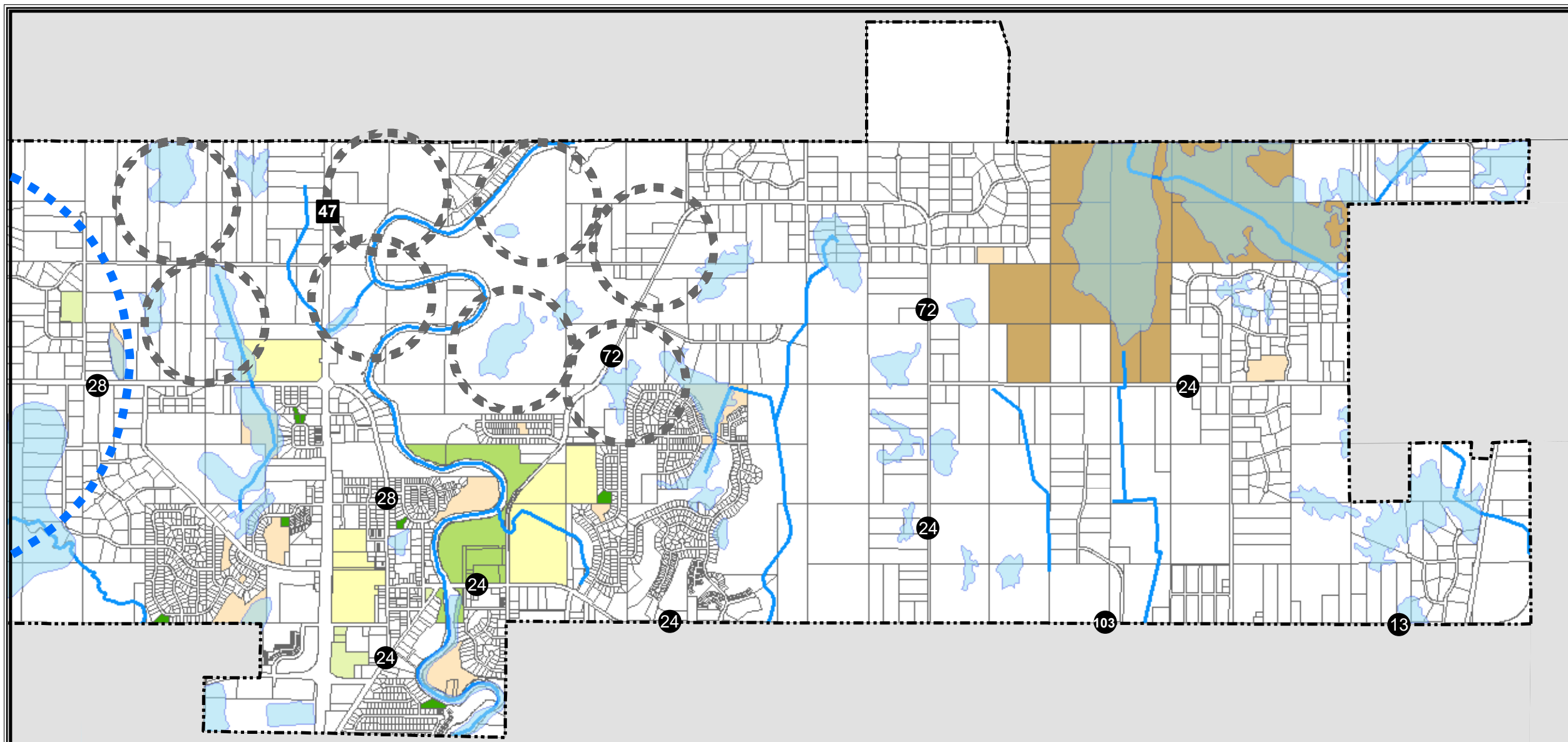
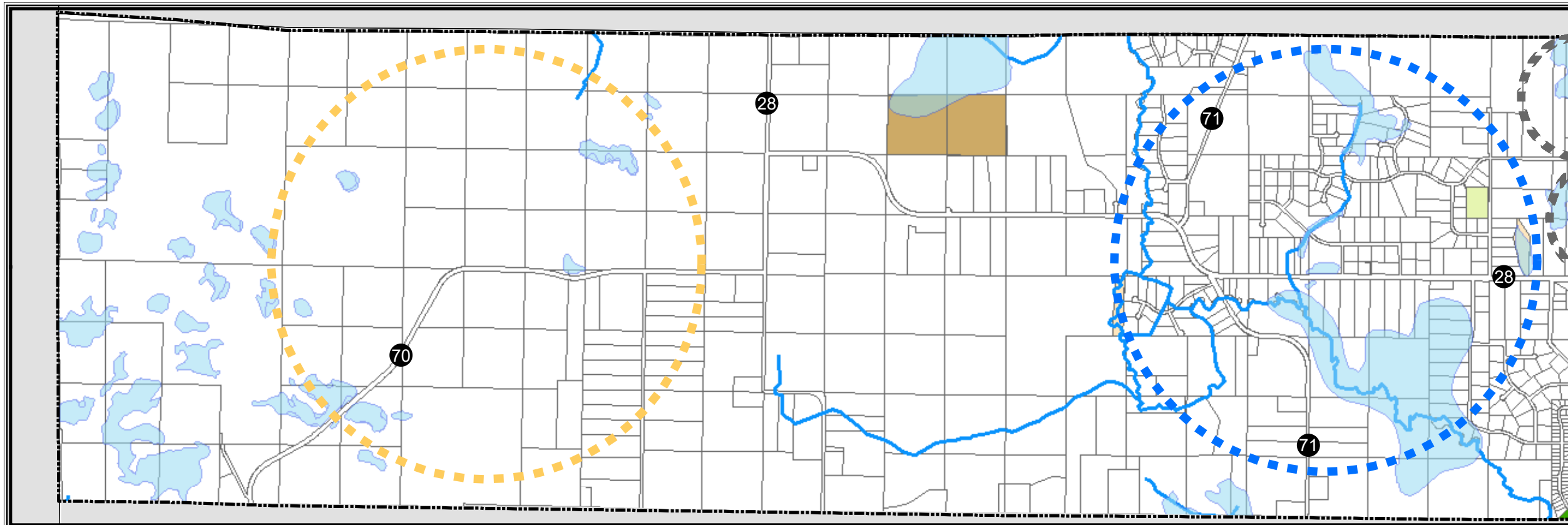



## Community Facilities & Recreational Programming

The City has a variety of parks that can be classified as Community Parks with a regional draw, Neighborhood Parks for the immediate half-mile service area, and Open Space which is for nature preservation, trails, or passive recreation. There are also recreational facilities within the City provided by Anoka County, the St. Francis School District, and the Department of Natural Resources. There are also recreational attractions and opportunities present in the community in the form of community events and geographic features like the Rum River.

### Community Parks

**St. Francis Community Park.** St. Francis Community Park is about 12 acres in size, which is adequate for a community park. The park has a great location and good visibility. There are several overlapping service areas in this area but this is due to the river and Highway 47. Continued improvements to the City's sidewalk and trail system could bolster this park's use. The parking facilities allow for users from throughout the area to use this park.



**Woodbury Park.** This park is located at 3646 Bridge Street NW, just west of the Rum River and east of downtown St. Francis. The park is .75 acres in size, and includes a gazebo, a fountain, gardens, seating, pathways, green space and a kiosk.



**Hidden Ponds.** The park on Roanoke in the Hidden Ponds development is 8 acres in size, and has a parking lot, playground, and ball field. It has excellent visibility, usability, and accessibility. Ideally, parks for ball field purposes would be larger in size. The property across the street has been discussed as a possible sports complex. If that occurred this park could be incorporated into it, if it could be done in a safe manner. It is located near future development areas and could be used independently as a neighborhood park, as well.





## Neighborhood Parks

**Deer Creek Park 1.** The park in the Deer Creek subdivision is located near higher density housing and is attached to a large wetland. This makes the parcel about 11 acres in size but with only about a 3 acre area of it is upland. With some improvements to the trail or sidewalk system this park could be accessed by a great number of users.



**DeGardner.** This park has poor access, visibility, and the outdated equipment was recently removed. It consists of 3 parcels, two a half acre in size and the third is an acre, for a total of about 1.3 acres. There are ponds located within the park that limit its usability. Prior to replacing equipment, the access to the park from the trail corridors on Highway 47 should be examined. If there are no solutions, perhaps a status change would be appropriate into a pedestrian corridor.



**Durigan Locher.** This park serves the area north of Bridge Street and east of Highway 47. The park is only about 1 acre in size and has limited accessibility, visibility, and connectivity. It could never be much more than a parcel housing playground equipment. There are limited areas available for expansion or replacement of this park. Further review of usability in conjunction with future development and of connectivity improvements would be warranted.



**Highland Woods.** Located at 3060 233<sup>rd</sup> Lane NW, this park serves the Highland Woods neighborhood. Park amenities include playground equipment, walking paths, and an informational kiosk. The park is 1.75 acres in size, and is contiguous with the County park to the west, and a 2.61 acre open space and wetland area to the south.



## Park and Trail Inventory

**Rum River Woods.** The park in the Rum River Woods development is underdeveloped and has overlap with the service area for the Community Park. It has river frontage and is 2 acres in size, which gives it some degree of potential. It is approximately 75 feet wide in size which is not ideal for parkland but also limits its other potential uses. This park could use sidewalks or trails to increase its connectivity.



**Seelye Brook (Deer Creek 3<sup>rd</sup>).** This park is 1.12 acres in size and located on a local road. It is a gateway to the Wickstrom Forest Park in Oak Grove. There is limited visibility in areas which could be a concern. However, it appears to serve the purpose for which it was acquired and provides service in an area that would otherwise be difficult.



### Passive Parks / Open Spaces

*Several open space areas have been acquired by the City. These parks are primarily natural areas with limited active recreation potential. They are to be separated from active park land as they serve a different purpose and given lower funding and programming priorities:*

**Creekview Estates.** There are two parcels platted as park in the Creekview Estates Subdivision, and as such may not be used for other purposes. The parcels are the location of the channel for Seelye Brook. There are no known plans for the parcels.

**Deer Creek Park 2.** Located on the southern edge of the City, this land was dedicated to be a future trail area around the wetlands. There is a strip of land between two houses providing access. With very limited access, it is unclear if this property could serve any other purpose.

**DeGardner Park 2.** This is a 13 acre site that is mostly wetlands located between the Woodhaven manufactured home park and the DeGardner Addition. It has been discussed as the potential future location of a boardwalk. This was platted as parkland, and could not be used for any other purpose.

## Park and Trail Inventory

---

**Dellwood River.** This is a natural area along the river where the City has a trail for public access. Most of the site is wetlands. The two access points where the trail meets a public street in between houses, which is not ideal.

**Edgewild.** The park in the Edgewild subdivision is slightly less than 5 acres in size and is on a local road adjacent to property owned by the DNR. The park is too small for any sort of development as a community-wide asset. The need for neighborhood parks in rural areas is lesser than the need in urban areas, due to the lower density and fewer available users. It may not be financially feasible to develop and maintain a park with this low service capacity potential. The DNR may have interest in taking over this property, due to its proximity to the WMA. There is limited development potential in the area making additional users for this park unlikely.

**Smith Lake.** This 10 acre property was acquired in the Smith Lake Wildlife Estates Subdivision for a larger park. It was discussed that this park could be a sports field use. It would need to be a destination park, as the surrounding neighborhood most likely would not have the population to support it. There are wetland areas within the park. Sports complexes are typically 20 – 40 acres in size, so if this site were to be developed as such, additional land may be necessary.

**Stone House Ridge.** Parkland dedicated for Stone House Ridge was a small amount of upland adjacent to a large wetland. The concept was to have a boardwalk connecting over the wetland.

**Sunrise Hills.** This 6.36 acre open space is located east of Roanoke Street NW and north of County Road 28. It consists primarily of wetland areas.

**Wickstrom Forest.** Adjacent to the City's Seelye Brook Park and Deer Creek Park 2 is the Wickstrom Forest natural area in the City of Oak Grove. The Cities of St. Francis and Oak Grove have enacted a joint powers agreement that allows for a parking area, trails, and a sledding hill to be placed on this property.

### Non-City Facilities: State Wildlife Management Areas

**Bethel Wildlife Management Area.** Bethel Wildlife Management Area, a State Park managed by the Minnesota Department of Natural Resources, is located on the northeastern boundary of the City of St. Francis.

**Carl E. Bonnell Wildlife Management Area.** Carl E. Bonnell Wildlife Management Area is located on west side of town.



### Non-City Facilities: County Parks

**Rum River North County Park.** Rum River North County Park, an Anoka County Park, consists of 80 acres located near the south-central boundary of St. Francis. It is the northern access to the Rum River Canoe Corridor. Amenities available at the park include picnic shelters, biking and hiking trails along the Rum River, canoe launch sites, canoe campsites, fishing pier, observation decks, a large playground and a restroom.

Rum River North County Park, located one block north of County Road 24 on Rum River Boulevard, is close to the County's St. Francis branch library, St. Francis High School, city hiking/biking trails, and a state-funded snowmobile trail. The Rum River North County Park includes beautiful natural features such as restored native prairie, great vistas of the Rum River, and thick canopies of mature hardwood trees.



## Park and Trail Inventory

### Trails

*The City of St. Francis has been developing a trail system that takes advantage of the amenities the community has to offer. Trails are constructed to offer a variety of users recreational opportunities. The existing trail system and future trails are identified on Figure P-4.*

### Waterways

*The Rum River runs north/south through the central area of St. Francis offering scenic views and canoeing opportunities.*



### School Facilities

*The St. Francis 2000 Comprehensive Plan identifies exploring the possibility of constructing a community pool in partnership with Independent School District #15.*

St. Francis Elementary - 22919 St. Francis Boulevard  
St. Francis Intermediate Elementary - 23026 Ambassador Boulevard  
St. Francis Junior High School - 23026 Ambassador Boulevard  
St. Francis Senior High School - 3325 Bridge Street  
Transition 15/Oakwood Learning Center - 2935 Coon Rapids Boulevard  
Crossroad School and Vocational Center - 4111 Ambassador Boulevard

## Recreational Programming

*Recreational programming is available through various community organizations located within the City of St. Francis.*

- District 15 Community Education Program
- North Metro Soccer Association
- St. Francis Traveling Baseball Team



## Community Festivals

Pioneer Days: Carnival, Craft/Food Booths, Parade, Bands, Fireworks



### **Parks Commission**

*For the development of the 2005 Park & Trail Plan, the City of St. Francis utilized the Park and Recreation Commission. The St. Francis Park and Recreation Commission served as an advisory commission to the City Council and met monthly. Since this time, the Parks Commission duties have been assigned to the City Council and sometimes designated to the Planning Commission. If the City were to see an increase in development, reactivation of the Parks Commission may be advisable.*

### **Open Houses**

*For the original 2005 Park & Trail Plan, the City conducted a series of open house events to receive resident input regarding existing park facilities to inform this inventory. Information received at the open house events indicates that residents of the City utilize and appreciate existing park facilities. Residents also requested additional ballfields for active play. In 2012, the Planning Commission hosted a public hearing and considered amendments to this plan.*

## Park and Recreation Policies

*Park and recreation planning in any community is a staged process. Developing a policy plan is the first and most critical stage of the planning process.*

The policy plan is a strategic management tool that reflects the community's general treatment of its recreation facilities and services, and provides more detailed guidance on park and trail development and maintenance standards. Community recreation standards are the means by which the City can express its goals and objectives in quantitative terms, which in turn can be translated into spatial requirements for physical resources.

### Park and Open Space Policies

- It is the policy of the City to preserve and protect its natural environment in order to enhance the residential quality of life in the community.
- It is the policy of the City to maintain and enhance the City's parks and to work cooperatively with Anoka County Parks Department to provide trail connections to the Rum River and Lake George Regional parks.
- It is the policy of the City to provide for additional neighborhood parks and open spaces in tandem with new residential development.
- It is the policy of the City to manage the City's unique land and water resources, to preserve and enhance those resources, and thus, raise the City's quality of life.
- It is the policy of the City to maintain the Scenic River District and continue to work with the Minnesota Department of Natural Resources to protect both the Rum River's Rural Scenic and Urban Scenic areas.
- It is the policy of the City to protect and preserve the natural environment by avoiding development in protected wetlands, steep slopes, and any other environmentally sensitive areas.
- It is the policy of the City to improve and enhance Woodbury Park as part of the City's Downtown Area.
- It is the policy of the City to expand its existing trail system by establishing a bituminous trailway system that provides safe and convenient pedestrian/bicycle access throughout the city and with internal and external connections to the Regional Park.



## Park and Recreation Policies

---

- It is the policy of the City to expand its sidewalk system to provide pedestrian accessways throughout the downtown, along Highway 47 and the newer residential developments.
- It is the policy of the City to consider additional recreational transportation improvement projects to the Rum River in order to cater to the growing needs of the community.

### System Policies

- Develop an on-going planning process for the establishment of parks and trails that responds to the Comprehensive Land Use Plan Policies as well as those identified herein.
- Develop goals and priorities for park and trail acquisition and development.
- Identify present and future park and trail needs on a regular basis for evaluation by the Park Board and City Council.
- Review the established park and trail plan annually to be used as the basis for development.
- Prepare a master plan for each component of the park and trail system to be used as the basis for development.
- Promote public participation in the planning process via the Park Board hosting a forum for open discussion of issues.
- Promote integration with other City activities, services and facilities.
- Identify the means by which to implement park and trail administration and operations (i.e. by the Park Board, City Council, administrative procedures, City ordinances).

### Acquisition Policies

- Acquire park and trail facilities to satisfy the recreational and transportation needs of the residents on both a neighborhood and community-wide basis.
- Identify means for park and trail acquisition (i.e. dedication, purchase, eminent domain, donation).
- Identify means for establishment of park and trail facilities within subdivisions (i.e. outlots, easements).
- Ensure the proper right-of-way width and easements are dedicated for sidewalks and trails during the subdivision process.
- Identify sources of funds to be utilized for acquisition (i.e. trail dedication fund, capital improvement program, bond issuance, grant programs, etc.).
- Establish who is responsible for park and trail construction within subdivisions.
- Determine to what extent wetlands, drainage ways, floodplain areas, etc. should be accepted as part of park and trail dedication within subdivisions.
- The inclusion of environmentally sensitive areas (lake frontage, native prairie, bluffs, unique vegetative associations, etc.) into park or trail facilities should be considered to contribute to the overall recreation system.
- Consider acquiring land for parks and trails at an early date to meet long range needs before development pressures render the property too expensive.
- Consider accepting parkland dedications consistent with the adopted park and trail plan and accepting only cash in areas that serve no system purpose.
- Consider crediting for dedication of park and trail land only those parcels that are not within delineated wetlands or that include slopes of no more than twelve percent (12%).

## Park and Recreation Policies

---

- In addition to the standard programs and facilities typically recognized by the City, consideration should also be given to the following areas:
  - Nature preservation
  - Historic preservation
  - Cultural enrichment
  - Facilities for the handicapped/disabled
  - Public activity areas and facilities in employment centers
  - Organized sports and recreational activities
  - Teen programs and facilities
  - Senior citizen programs and facilities

### Programming and Development Policies

- Provide parks as identified in this plan and trail links that connect residents conveniently to the community and neighborhood parks as well to the Downtown Area and other community assets. This trail system would provide both active and passive recreational opportunities for residents.
- Expand the multi-modal trail system with connections to the town center and neighborhoods.
- Provide for pedestrian and bike connections to and from the town center to encourage multiple activities.
- Provide for an adequate amount of open space throughout new developments, which serve both aesthetic and recreational functions and also serve as buffers and boundaries between incompatible land uses. Require an adequate number of trees in new neighborhoods and the replacement of trees if removed.
- Develop new residential areas as pedestrian-oriented neighborhoods with a mix of housing types, open and recreational spaces, trail linkages, trees, adequate buffering from incompatible land uses, and traffic calming measures.
- Promote working relationships within Independent School District #15, the surrounding communities, the County, School Districts, private and/or non-profit organizations in developing joint ventures for shared use of recreational parks, open spaces, facilities and the citywide trail system.

## Park and Recreation Policies

---

- Work specifically with other institutional organizations in St. Francis to promote sharing agreements of their facilities with other community groups to have access to other additional recreational and cultural opportunities.
- Create and maintain an attractive, diverse, and interesting system of parks and trails.
- Create a City-wide park and trail system designed to minimize conflicts between pedestrians and motor vehicles.
- Minimize park and trail construction costs by constructing trails in conjunction with state, county, and City street improvements.
- Parks and trails constructed on a priority basis, according to capital improvement plan and available funds; trail priorities may be:
  - Trails along major streets which focus on pedestrian and bicycle safety and which provide direct access to City and regional destinations and parks.
  - Trails that will serve the most intensely used areas.
  - Trails construction within existing parks and upon City right-of-way, easements and property.
  - Trail inclusion within new park and subdivision development.
  - Completion of links between existing trails and other communities.
- Park priorities may be:
  - Establishment of parks in association with new subdivisions.
  - Establishment of parks in undeveloped areas.
  - Creation of neighborhood and community-wide parks
  - Upgrade/improve existing park equipment.
- Identify types of financing to be utilized for park and trail acquisition and development.
- Review park dedication fees in comparison to surrounding areas and in regard to City needs (land vs. cash).
- Encourage the private sector to provide recreational opportunities/facilities.
- Provide support facilities in conjunction with trail development.

## Park and Recreation Policies

---

- Organize and outline recreation programs prior to initiation and implementation.
- Identify where the establishment of user fees is appropriate to meet recreation costs.
- Determine under what circumstances unsolicited gifts and donations will be accepted if they are free of obligations or potential future impacts.
- Determine under what circumstances volunteer efforts will be utilized to expand the City's recreational elements.
- Active use recreation areas should be designed for year round use with an established system of maintenance.
- Park and playground buildings should be compatible with surrounding activities with regard to scale, design, color, setbacks, and materials.
- Park and trail development should minimize impacts on adjacent properties through design provisions including, but not limited to:
  - Adequate off-street parking.
  - Appropriate orientation and location of buildings and activity areas.
  - Screening, buffering and landscaping.
  - Adequate setbacks and physical separation.
- Coordinate facility development with the needs of community residents, Park and Recreation Commission services, athletic associations, civic groups, etc.
- Maximize park accessibility by City residents to best serve the area.
- Coordinate annual park events.
- Consider existing physical site amenities (natural or man-made) and encourage the establishment of new site amenities when planning and developing park areas.
- Ensure that the proper right-of-way widths are dedicated or easements are established for sidewalks and trails during the subdivision process.

### Facility Purpose and Design

- Establish park and trail facilities that provide recreational as well as functional uses.
- Provide varying types of trails to be used as the basis of planning and development for the park and trail system.
- Trail grades should ensure handicapped accessibility.
- Design and construct trails according to the standards established by the National Park and Recreation Association, the Minnesota Department of Transportation, and Rails-to-Trails Conservancy.
- Prior to the development of each park area, a design plan will be prepared which shows the types, locations and sizes of proposed facilities and estimated costs.
- Maximize park accessibility by City residents to best serve the area in which the facility is located by requiring either vehicular or pedestrian access or both (depending on the size and classification of the park).
- The City may consider the utilization of trail corridors as ski touring or snowmobile routes during the snow season and consider other possible uses of such corridors when safe and proper.
- Maintain all trails in good repair and ensure that designated trail segments are kept open and clear of snow throughout the year unless designated as winter use trails.
- Consideration shall be given to safety, visibility, and emergency access into parks when acquiring land or planning for development.
- The City may consider developing policies for ATV, mountain bike, horseback riding and in-line skate usage.
- Define the types of parks that exist and are to be established in the City and develop policies for each.

### Maintenance and Operation

- Provide for the efficient maintenance and operation of clean, orderly, controlled, safe, and attractive parks and trails. Park maintenance and operation shall safeguard the physical condition of trails from deterioration or damage due to weather, vandalism, or other natural or human causes.
- Develop a clear and concise system of park and trail graphics and signage that direct people along trails and into parks to specific points of interest.
- Define specific park and trail safety rules.

### Public Relations and Community Issues

- Involve park system user groups and other individuals in the ongoing planning and budgeting for the park.
- Sponsor events in the park to further enhance community sense of ownership and to build community.
- Develop ways in which to promote citizen interest and involvement in the City's park and trail system.
- Publish a pamphlet that shows the trail routes, parks, service and public facilities.
- Monitor characteristics of use, safety, and other factors periodically throughout the park and trail system.
- Provide facilities and services to all residents of the community.
- Develop ways to organize recreation programs and facilities to maximize participation and overcome physical poor economic limitations that may prevent equal opportunity, regardless of age, race, sex, religion, or place of residence.

## Plan Development

The Plan Development chapter of the St. Francis Park and Trail System Plan will guide continued development of the City's park and trail system. Existing facilities are identified herein in greater detail with recommendations for continued use and vitality. In addition, search areas for future parks have been identified based upon the growth strategies outlined in the City's Comprehensive Plan. Future park areas do not target specific properties, but instead identify general target areas toward the goal of providing the City with the ability to reserve land from development as it becomes available.

Trail development is addressed somewhat differently in that future trail corridors have been specifically identified. The basic concept of the trail element of the Park and Trail System Plan is to provide for a multi-purpose trail network that connects to important recreational and social centers of the community. The trail element of the plan also seeks to provide intra-community connections with regional trail corridors provided by other agencies. In addition to the primary trailways that follow street rights-of-way, a number of overland trail segments are proposed which serve two purposes. First, these segments provide more direct access to neighborhoods or destinations. Second, overland trails may serve as linear parks and provide a transportation function through areas of high amenities.

*Park and trail system plan preparation requires recognizing a park classification system that will cater to the recreational need of all residents. The City of St. Francis recognizes the importance of establishing and using park and recreation standards as:*

1. An expression of minimum acceptable facilities for citizens of the community;
2. A guideline to determine land requirements for various kinds of park and recreation areas and facilities;
3. A basis for relating recreational needs to spatial analysis within a community-wide recreation system;
4. One of the major structuring elements that can be used to assist with development; and
5. A means to justify the need for parks and open space within the overall land use pattern of the City.



## Plan Development

---

The following park classification system is intended to serve as a guide to planning, not a blueprint. The standards are to be coupled with conventional wisdom and judgment relating to the particular situation to which they are applied and specific local needs. Occasionally, more than one component may occur within the same site, particularly with regard to a specialized use within a larger park.

<b>Community Parks</b>	
Use	Designated area of diverse environmental quality which may include areas suited to intense recreational facilities such as athletic complexes as well as passive type areas, depends largely upon the site location, suitability and community need
Service Area	Serves the entire community or large segment thereof.
Population Served	All ages, toddler to retiree, entire community for cities up to 25,000
Desirable Size	20 to 60 acres
Acres/1,000 Population	5.0 – 10.0 acres
Site Characteristics	Provides for a combination of intensive and non-intensive development ranging from play equipment to trails, may include natural features, such as water bodies or forested land, must include support elements such as rest rooms, drinking water, parking and lighting. May also include community wide playfields and sports complex type uses.

<b>Open Space</b>	
Use	Designated area for protection and management of the natural/cultural environment, corridors to support the trail plan, and/or holding zones for future parks acquired before prior to their needed programming. Such parks should only be acquired on an extremely limited basis.
Service Area	No applicable standard, scattered among City parks of all sizes
Population Served	All ages
Desirable Size	Sufficient to protect the resource and accommodate recreational uses
Acres/1,000 Population	Variable
Site Characteristics	Variable, depending upon the resource being protected

Neighborhood Parks	
Use	Designated active and passive recreation areas
Service Area	Large neighborhood sizes of up to 5,000 persons within $\frac{1}{4}$ or $\frac{1}{2}$ mile radius
Population Served	Focus upon ages 5 through 39 with emphasis upon ages 5 through 18
Desirable Size	3 to 10 acres
Acres/1,000 Population	1.5 – 2.0 acres
Site Characteristics	Suited for multi-use recreation development, easily accessible to neighborhood population, geographically centered with safe walking and bike access, may include school facilities

## Park Facilities

For new and existing facilities, the goal of the City of St. Francis would be to keep the same level of recreational opportunities available to the public as the City grows while finding ways to more efficiently provide park related services. This will ensure that the City can afford to keep the system maintained at the current high quality level by saving resources for routine maintenance while also taking care of future park needs.

*The following are the key components for the park system of the City of St. Francis:*

## Categorization

Parks should be clearly categorized based on use. This allows the City to focus resources in the appropriate manner. The City intends to focus on two key active park categories and categorize the existing parks and future parks as such. The two major categories are neighborhood and community level parks, as defined above. Programming for community level parks would be facilities that draw from the City as a whole such as ball fields and other such facilities that would require parking lots and sanitary facilities. Neighborhood level parks would be for playground equipment and other limited facilities intended to serve residents within the specific service area.

## Accessibility

Parks should be located on higher classification roadways. Parks should not be located on local streets where users will interfere with the residential nature of the area. Parks should have sidewalks or trails leading to the site from the neighborhood residences. Every park should be designed to handle the traffic it generates. Parks should connect to one another and key community facilities via the trail and sidewalk system.

## Usability

Neighborhood parks should be sized to reflect the community values but are recommended to be between 3 and 10 acres in size. This allows for centralized facilities which lowers maintenance costs and increases usability of the park. Parks that are intended to serve the community as a whole should be 20+ acres in size unless they serve a special purpose for which a smaller site is sufficient. Parks should be given names and signage that are independent of the subdivision they are found in to avoid deterring residents from other neighborhoods using the park. Existing parks may not meet these standards and can be considered for expansion, replacement, supplementation, or reassignment.

## Visibility

Parks should have good visibility into the site from the right-of-way and the neighborhood. Good visibility increases safety and limits opportunities for vandalism and crime. Vandalism results in premature replacement costs.

## Maintenance

In order to limit liability, park equipment should be replaced on a regular schedule. The City should plan on replacing equipment and amenities every 20 to 25 years and conduct routine safety inspections. A capital improvement budget should be made to track replacement costs. The City should plan on replacing equipment as a priority over new equipment, unless new development is prioritized in certain instances.

Open space should only be acquired when there is an identifiable public purpose. Ownership of the land comes with responsibilities for maintenance. When the City does come into ownership of property, low maintenance vegetation should be considered. If an open space parcel is remote, contracting of maintenance may also be considered.

## Service Areas

The City identified the appropriate distance for a service area as a ½ mile radius for neighborhood parks. This is based on a reasonable walking distance to the park for neighborhood users. Parks serving neighborhoods should serve more than one development. Parks should be located in areas that are accessible to as many people as possible to maximize use and limit the total amount of parkland needed.

The City of St. Francis has several lower density rural residential neighborhoods. It has been the City past practice to provide parks in these neighborhoods. Rural development densities are lower and the service areas would end up with a very limited amount of residences within ½ mile. In the 2030 Comprehensive Plan update, rural residential development densities were lowered to 1 unit per 10 acres. At this density, the service area population for neighborhood parks will likely be too low to support the investments in park facilities. Larger scale community parks or other types of special destination parks are appropriate for these areas provided they are not dependent upon a central location.

## Trails

*A park plan and ultimate park system is truly not complete without a system by which residents are afforded a convenient and safe means to access such facilities. In this regard, the designation of future trail corridors is considered a worthwhile planning effort.*

A primary goal of the St. Francis Park and Trail System Plan is to provide linkages between the City's various park facilities and residential centers. To achieve this, desired trail locations are identified prior to new growth so when opportunities arise, various trail segments can be established or reserved.

Retrofitting trailways into an existing development pattern is more difficult than identifying new corridors for new development. Therefore, an effort to identify connection points to existing development should be considered prior to additional new growth. The trails illustrated on the Park and Trail Plan Map will likely consist of three types of trails: on-street trails, grade separated trails, and overland trails.

On-street trails are those that utilize local streets as connecting links between other types of trail segments. They are vital in that they provide ingress and egress through residential areas, which is commonly the place of origin for most trail uses.

Grade separated trails are those that are located parallel to a street, often within the street right-of-way, but do not share the same paved surface. Grade separated trails are typically set apart from the driving surface by a grasses and/or landscaped median area. Grade

separated trails provide safer access along high volume transportation corridors and depend on signalized intersection of specific pedestrian crossings to cross streets with high traffic counts.

Overland trails are those that provide pedestrian or bicycle connection in areas where it is not desirable or feasible to utilize on-street or grade separated trails. These are wider corridors of at least 20 feet and up to 100 feet wide which may include elements of a linear park such as open space, vegetative plantings or other complementary features in addition to the paved trail surface.

It should be noted that identified future trails may also be installed as sidewalks if it fits the neighborhood environment in a more proper fashion.

Sidewalks are typically maintained by the neighboring property owners unless designated for routine community maintenance. Trails require more City investment in regards to seal coating, upkeep, and identified routine maintenance. Therefore, as more trails are installed, the more the City commits resources to maintaining trails. In some situations, a sidewalk or bike lane could serve the same purpose of a trail. Trails that the City does not wish to maintain and are not used year round by the public could become seasonal and closed during winter. Trails should be put on a regular maintenance schedule which should include seal coating and planning for replacement.

*Development of a comprehensive trail system plan as part of a park and trail plan for the City should incorporate the following priorities in no particular order:*

1. Obtain no cost trail easements in accordance with an adopted master plan as subdivision opportunities permit.
2. Construct trail systems within new subdivisions concurrent with the development process. Have a goal that within five years of construction of initial trails within subdivisions, added trail system components will be constructed to “loop” new subdivision trails so that extensive short stub trails with no destination or looping do not exist for any significant length of time. City funds would be used to complete a loop through a development only when a connecting segment must be acquired and constructed.
3. Evaluate existing developed areas for trail looping. A two or three mile long trail loop circling through a development area will likely receive high local usage and can be eventually incorporated into a large City-wide system.
4. Trail routes along major streets and roadways that have the most direct access to primary pedestrian destinations.

5. Where trails will serve commuter destinations.
6. Where trails lead to parks, playfields, and other recreational facilities.
7. Where trails will link together separate portions of the St. Francis trail systems with each other.
8. Where trails provide access to regional trails.

The Park and Trail Plan Map focuses upon the designation of future trails based upon the location of varied trail routes and lengths, connection to existing trails in neighboring communities, connection to various destinations, availability of land and anticipated development areas. These trails should be acquired and developed as the opportunity is presented.







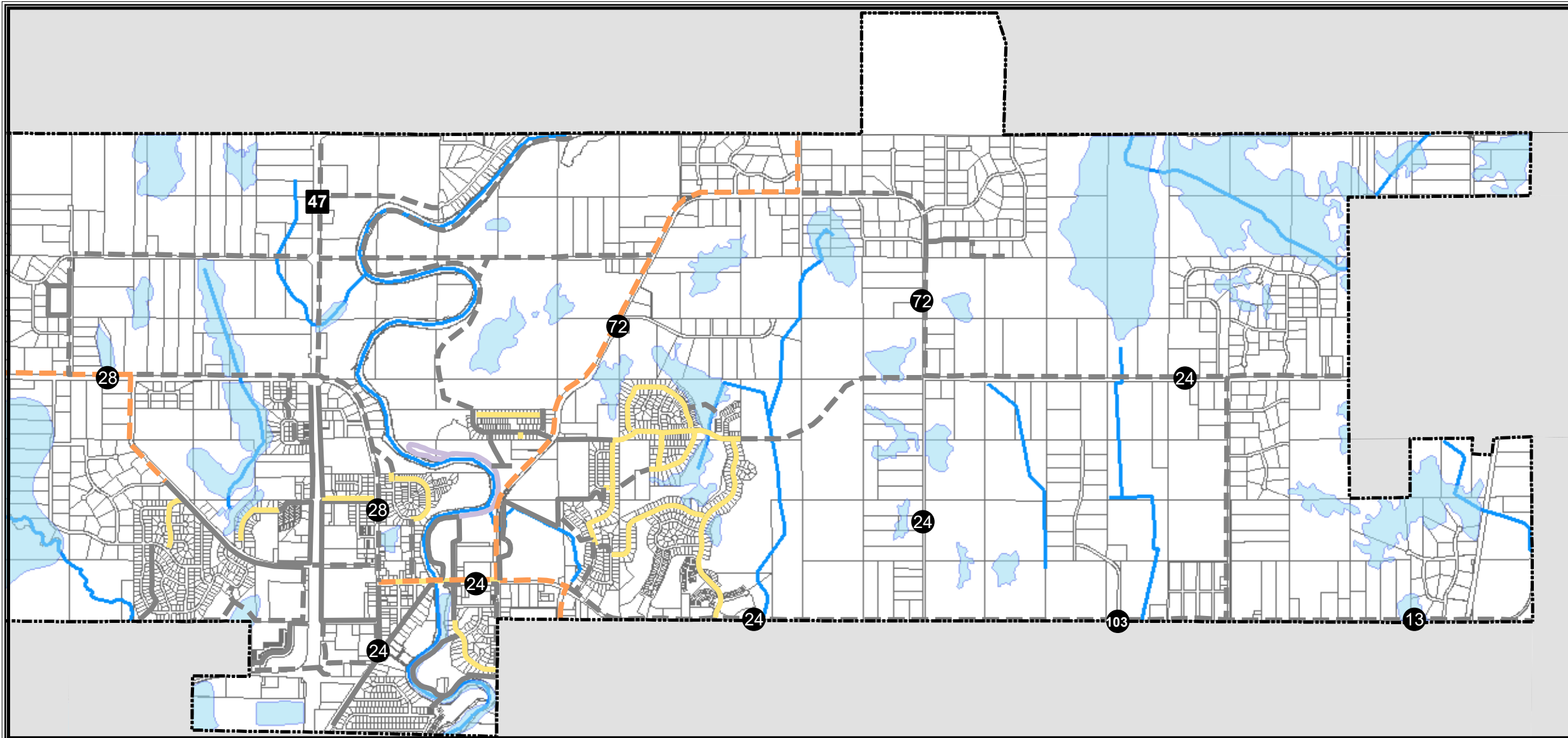
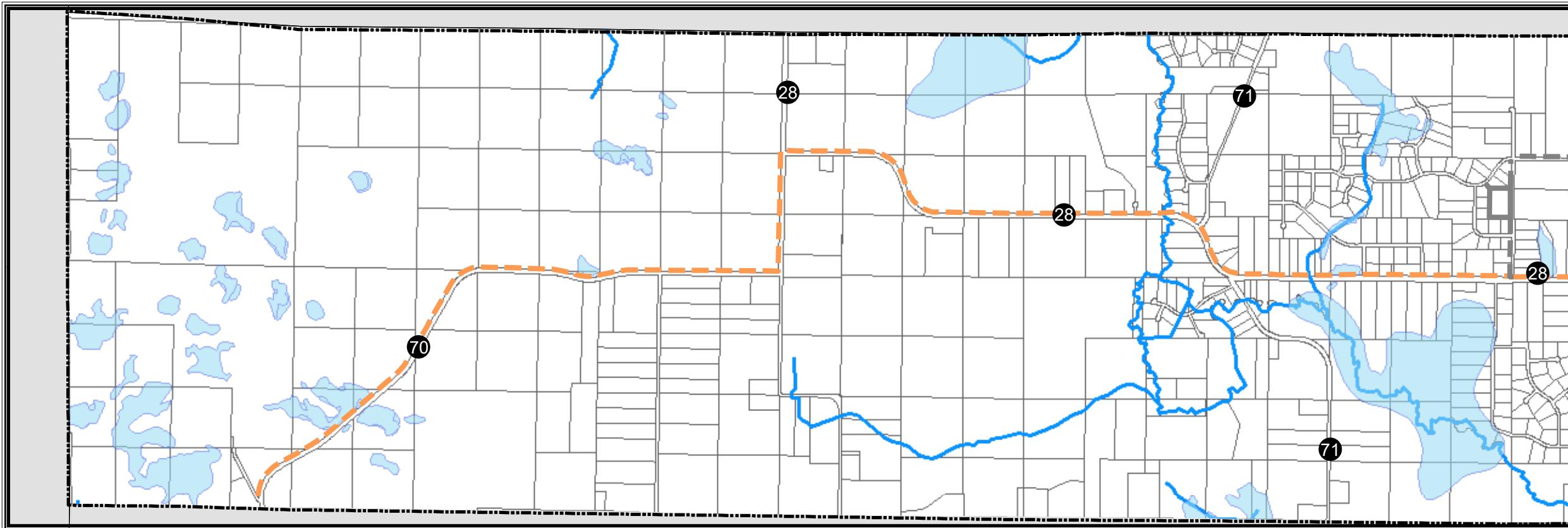

### **Future Park and Trail Facilities**

*The attached maps depict the location of future park and trail facilities for the City of St. Francis. Neighborhood parks are intended for areas that will have a higher number of residential units and the need for neighborhood facilities. Future community parkland is proposed to be located between the Rural and Urban Residential neighborhoods and in areas easy for the community-at-large to access. Trails are placed in key locations to provide connectivity from the park system to key community resources.*





**Trails**

-  Existing Bituminous Trail
-  Existing Concrete Sidewalk
-  Existing Limestone Trail
-  Existing Regional Trail
-  Future Trail Segments
-  Proposed Regional Trail
-  Rivers & Streams
-  Protected Waters

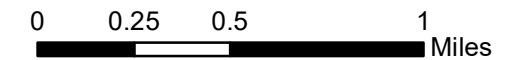
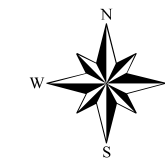

Source: Anoka County GIS; MN DNR; Bolton and Menk, Inc; Northwest Associated Consultants  
April 2015





Park and Trail System Plan

Figure P-4

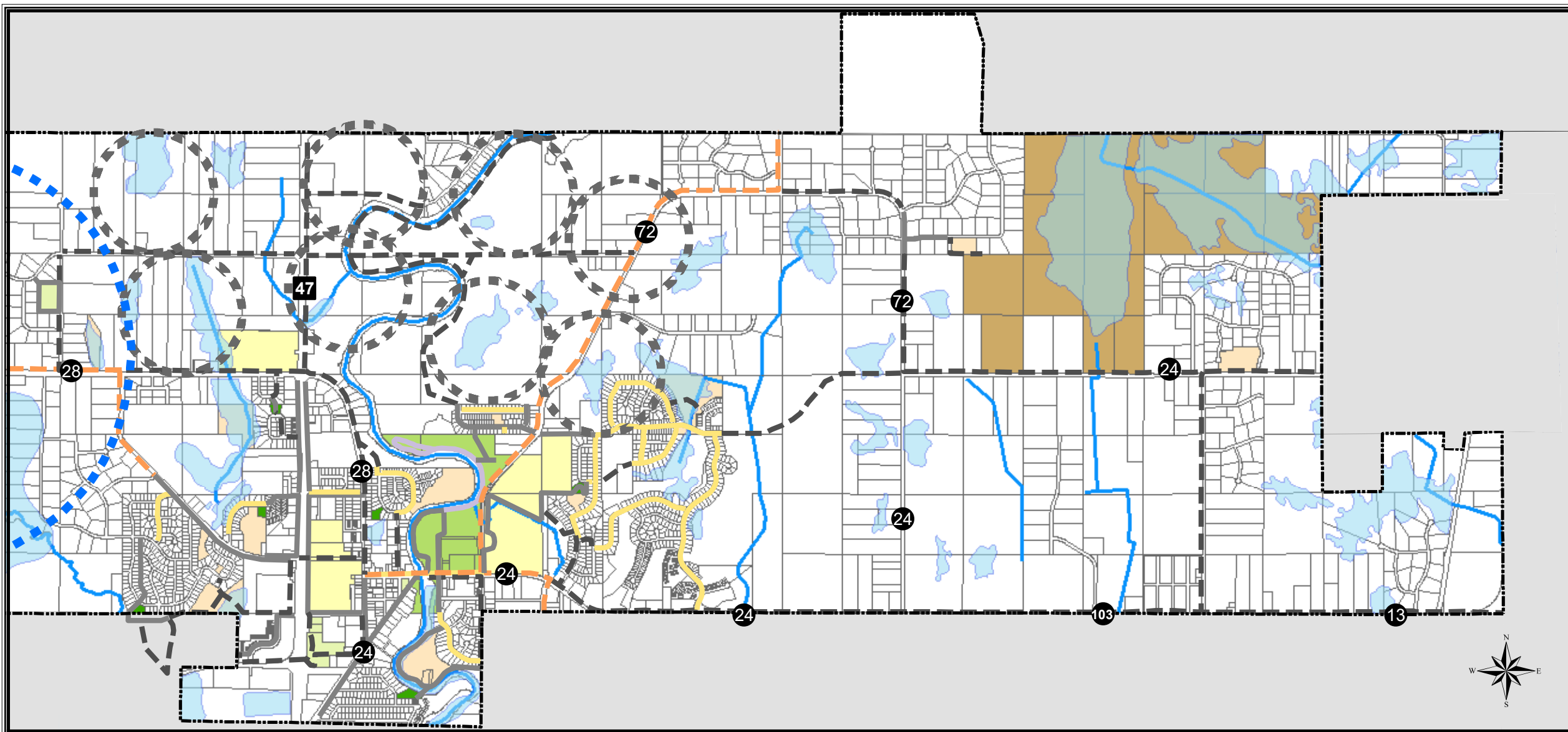
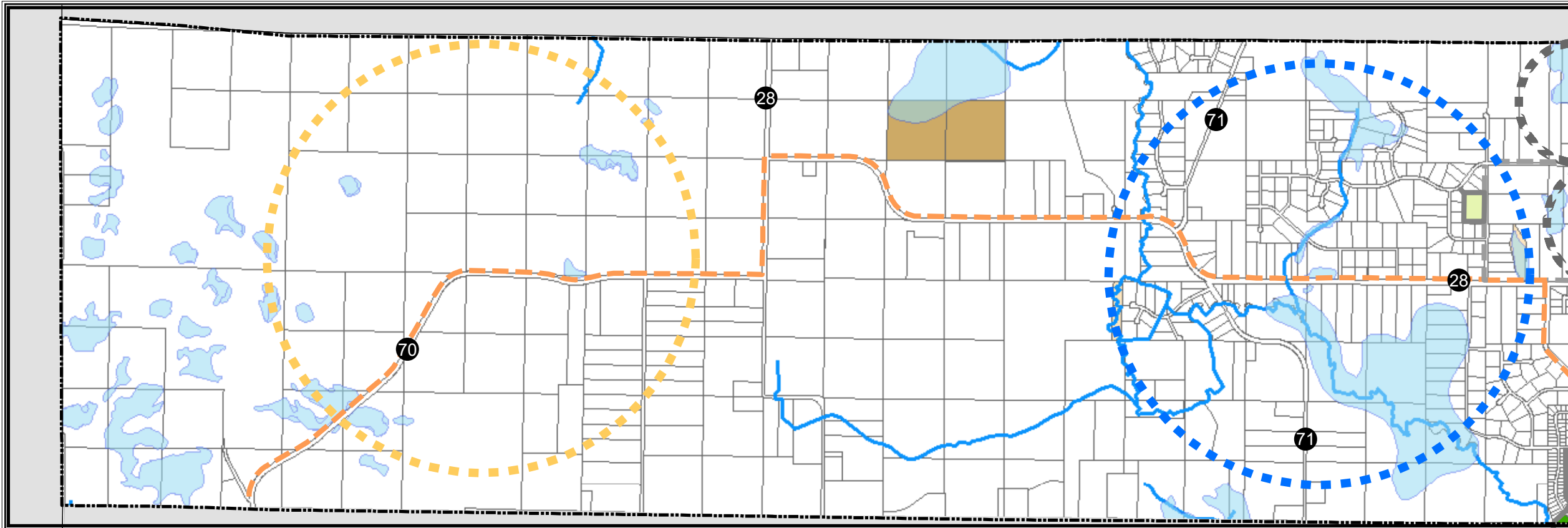

**Parks**

- Community Park
- County Park
- Neighborhood Park
- School District Properties
- State Wildlife Mgt. Areas
- Open Space

**Trails**

- Existing Bituminous Trail
- Existing Concrete Sidewalk
- Existing Limestone Trail
- Future Bituminous Trails
- Proposed Regional Trail

- Rivers & Streams
- Protected Waters
- Future Neighborhood Park Search Areas
- Future Community Park Search Areas
- Future Regional Park Search Areas

0 0.25 0.5 1 Miles

Source: Anoka County GIS; MN DNR; Bolton and Menk, Inc; Northwest Associated Consultants April 2015





# Implementation

## Introduction

The final phase of the Park and Trail System Plan establishes a process of projecting land acquisition and trail improvements, setting priorities, and scheduling for their provision and financing over a period of time. This process produces a long range guide for recreation and requires that the City look toward the future to anticipate capital expenditures. This section does not take the place of a capital improvements plan in that precise costs are beyond the scope of this document, however, the City must consider its five year priority list, analyze the financial situation, and obtain cost estimates for the desired improvements.

## Land Acquisition

Park and trail land dedication will play a major role in acquiring and developing park/trail facilities. Acquisition through dedication is a long term process since land can only be obtained as the abutting land is developed. While the outright purchase of land is many times prohibitive due to investment costs and anticipated benefit per capita through the City, it will be necessary where developments are already in place and lack recreational facilities or to acquire special, distinct pieces of land which would otherwise be difficult or impossible to obtain through park dedication. While portions of St. Francis contain developments that are already in place where several of the trail corridors are proposed and will likely require land acquisition through purchase or the establishment of easements, the utilization of road rights-of-way can also provide an easy alternative for establishing public trail routes.

For every component added to the park plan, the maintenance responsibility should be considered. Additional parks mean additional maintenance costs and routine scheduled replacement. Future park areas should be limited to what is necessary and what can serve the public in an efficient and organized manner. Trails should only be used when a trail is necessary to separate bicycle and pedestrian traffic from higher classification roadways. Bicycle lanes and sidewalks could replace trails on the trail plan when feasible.

In order to provide the safest parks possible, the City will need to set routine maintenance and replacement schedules. The cost for replacing and maintaining existing equipment should be considered when analyzing acquisition or development of new facilities.

Minimum park standards should be adhered to, as much as feasible, in order to ensure new parks are a fit within their intended category, accessible, usable for their intended purpose, visible and safe, easy to maintain, and have a specific service area. Such standards should be incorporated into the park plan to ensure the City is communicating its intent to the public and potential subdividers of land.

The City should also consider divestment of parkland that no longer serves its purpose in order to reallocate resources for acquisitions that are a better fit. Divesting parkland is a serious matter that should only be done in cases where the park was acquired for a purpose that no longer fits within the City's goals and policies. Prior to divestment, the City may need to process a Comprehensive Plan Amendment and in some cases a rezoning. Any money acquired from divestment would need to be placed in the Park Dedication Fund.

### Concept Planning

Concept plans are site specific and serve as the basic documents for the layout, facility mix, landscaping, and construction details for a park or recreation facility. For this reason, they are best prepared once the Park and Trail System Plan has been completed and location of individual park sites determined. They are based upon a well-defined program of recreation facilities and services to be provided and the overall physical arrangement of such. Such plans are not provided within this document, but should be pursued in future years. Their preparation will become a necessity in defining project costs as part of the yearly budgeting or capital improvement process.

### Capital Improvement Process

Capital improvement programming provides an instrument for carrying out the objectives and recommendations of the St. Francis Park and Trail System Plan. Through prioritization of five year capital needs for the City's park and recreational facilities and identifying the amount of money available to finance the improvements during this period, the City will be able to determine which improvements are necessary in terms of their ability to pay. The capital improvements program (CIP) is a flexible process, in that as the social, physical and financial conditions change within the City, the priority of the scheduled projects may also change. In response to the changes in the City, the CIP must be an ongoing process. Each year, the CIP should be re-evaluated for consistency with the plan, current recreational needs, and fiscal condition of the City.

*The following process should be utilized by the Park Board, Planning and Zoning Commission, and City Council when reviewing potential park capital improvement projects:*

1. Establish a five-year priority list of park/trail capital improvements that reflects current and projected recreation demands. Annually review and revise the five-year priority list to reflect current demand and needs.
2. Analyze the City's current financial situation.

3. Obtain up-to-date cost estimates for high priority items.
4. Develop project descriptions and plans for the desired improvements which include proposed scheduling and phasing.
5. Make copies available of the CIP for public inspection prior to the City Council's presentation of the annual budget at the required public hearing.
6. Begin the process over again following approval of the CIP and the beginning of another calendar year.

It is recommended that a specific annual CIP review schedule be established for the review of potential park/trail projects. This will enable persons who wish to request consideration of new items to present their position in ample time to change the CIP, if necessary, in a manner consistent with community needs and reducing or eliminating financial commitments being made for projects which might not proceed to the final construction stage in the event they are deleted or moved back on the priority list.

### **Minnesota Department of Transportation Grant Programs**

While park land acquisition and development are capital outlays that are typically financed with the revenues from City dedication or general funds, there are other methods available to assist the City in raising necessary money for large projects.

*The following outdoor recreation and trail grant programs through the Minnesota Department of Natural Resources may be available to the City if the intended project(s) comply with the submission criteria.*

### **Outdoor Recreation Grant Program**

**Program Purpose:** To increase and enhance outdoor recreation facilities. Provides matching grants to local units of government for up to 50 percent of the cost of acquisition, development, and/or redevelopment costs of local parks and recreation areas.

**Eligible Projects:** Park acquisition and/or development/redevelopment including, among others, internal park trails, picnic shelters, playgrounds, athletic facilities, boat accesses, fishing piers, swimming beaches, and campgrounds.

## Implementation

---

**Minimum Requirements:** Project proposals must include at least one eligible primary outdoor recreation facility and have a total project cost of at least \$10,000.00. Land proposed for development and/or redevelopment must be owned by the applicant or be part of an acquisition project. Significant progress must be completed on active projects before an additional proposal can be submitted.

**Program Funding:** A maximum of 50 percent of the total eligible project costs. Applicants must be able to fund at least 50 percent of the total project costs. The local share can consist of cash or the value of materials, labor, and equipment usage by the local sponsor or by donations or any combination thereof. Costs must be incurred and paid for before reimbursement can be made. Applicants are eligible to receive more than one grant.

### National and Scenic Area Grant Program

**Program Purpose:** To increase, protect and enhance natural and scenic areas. Provides matching grants to local units of government for up to 50 percent of the cost of acquisition of natural and scenic areas.

**Eligible Projects:** Eligible projects include fee title acquisition and permanent easement acquisition. Minimal betterment activities are eligible as part of the proposed acquisition project and include interpretive, educational or boundary signing and protective fencing.

**Minimum Requirements:** Project proposals must have a total project cost of at least \$10,000.00. Significant progress must be completed on active projects before an additional proposal can be submitted.

**Program Funding:** A maximum of 50 percent of the total eligible project costs not to exceed a maximum grant of \$500,000.00. Applicants must be able to fund at least 50 percent of the total project costs. Costs must be incurred and paid for before reimbursement can be made. Applicants are eligible to receive more than one grant.

### Local Trail Connections Grant Program

**Program Purpose:** The emphasis of this program is to promote access between people and desirable destinations, not to develop significant new recreation facilities. Its primary purpose is to complete trail connections between where people live (e.g. residential areas within cities and communities) and significant public recreation facilities (e.g. parks and other trails). Priority will be given to residential connections to state and regional facilities and linking existing trail segments.

## Implementation

---

**Eligible Projects:** Land acquisition and trail development. However, acquisition of trail right-of-way will only be eligible when it is proposed in conjunction with trail development. Land purchased with this fund will require a “perpetual easement for recreational trail purposes,” and trails developed with these funds will require a 20 year maintenance commitment by the project sponsor. Projects inside state park boundaries, state trail corridors, or elements of the Metropolitan Regional Open Space System are ineligible.

**Minimum Requirements:** Fifty percent “cash match” for eligible elements of the project proposal is required.

- Neither this funding source nor the cash match can be used for in-house labor services and/or to meet existing payroll (i.e., only contract services, materials and supplies are reimbursable).
- Federal Recreational Trail Grant Program, Regional Trail Grant Program, Metropolitan Council Funds and other state funds are not eligible cash matches for this program.
- Local/area support must be demonstrated by providing resolution, or minutes of council hearing.

**Program Funding:** Project proposals must result in at least \$5,000.00 and no more than \$100,000.00 of reimbursement.

### Federal Recreational Trail Program

**Program Purpose:** The Minnesota Recreational Trail Users Association has recommended the following priorities:

- Projects that accommodate both motorized and non- motorized uses, including same-season access corridors.
- Projects that involve urban youth corps workers such as the Minnesota Conservation Corps will be given special consideration.
- Any eligible all-terrain vehicle, off-highway motorcycle, off-road four by four vehicle, and snowmobile projects. Priority will be given to trail projects and trail linkages to existing systems over equipment purchases.
- For all horse, in-line skate, cross-country ski, hike, and bicycle (including mountain bicycle) projects, priority will be given to trail linkages and restoration to existing trail systems, necessary trail facilities, or trail signage to improve safety.



## Implementation

---

**Eligible Projects:** Motorized (snowmobiles, off-highway motorcycles, all-terrain vehicles and four-wheel drive trucks) and non-motorized (hike, bike, ski, horse, in-line skate) trail projects are eligible for funding.

- Maintenance/restoration of existing recreational trails.
- Development/rehabilitation of trail side and trail head facilities and recreational trail linkages.
- Purchase and lease of recreational trail construction and maintenance equipment.
- Construction of new trails on federal, state, county, municipal or private lands.
- Acquisition of easements and fee simple title to property for recreational trails.
- Redesign/relocation of existing trails to benefit/minimize the impact to the natural environment.

**Minimum Requirements:** Fifty percent “cash match” for eligible elements of the project proposal is required.

- Neither this funding source nor the cash match can be used for in-house labor services and/or to meet existing payroll (i.e. only contract services, materials and supplies are reimbursable).
- Regional Trail Grant Program, Local Trail Connections Grant Program and Outdoor Recreation Grant Program are not eligible cash matches for this program.
- Federal funds can be used as the cash match as long as the share attributable to the federal government is less than 95 percent of the cost of the project.
- This program may be used in tandem with DNR Grant-in-Aid Agreements for capital improvements to pay for activities eligible under both programs (contract services, materials, etc.).

**Program Funding:** Project proposals must result in at least \$5,000.00 and no more than \$100,000.00 of reimbursement.

### Regional Trail Grant Program

**Program Purpose:** The primary purpose of this program is to promote development of regionally significant trails. Primary determinants of significance include length, expected use, and resource quality/attractiveness.

**Eligible Projects:** Land acquisition and trail development. Priority will be given to projects that provide a useable trail. Land purchased with this fund will require a “perpetual easement for recreational trail purposes,” and trails developed with these funds will require a 20 year maintenance commitment by the project sponsor. Projects inside state park boundaries and state trail corridors are ineligible.

**Minimum Requirements:** Fifty percent “cash match” for eligible elements of the project proposal is required.

- Neither this funding source nor the cash match can be used for in-house labor services and/or to meet existing payroll (i.e., only contract services, materials and supplies are reimbursable).
- Federal Recreational Trail Grant Program, Local Trail Connections Grant Program and Metropolitan Council Funds are not eligible cash matches for this program.

**Program Funding:** Project proposals must result in at least \$5,000.00 and no more than \$250,000.00 of reimbursement.

### Fishing Pier Grant Program

**Program Purpose:** To improve fishing opportunities, especially to meet the needs of children, the elderly, and people with disabilities.

**Eligible Projects:** Development and installation of fishing piers. Also, the program provides for the development or improvement of shore fishing sites or shore fishing platforms. Local units of government provide public land, accessible sidewalk/path, accessible parking space and on-going maintenance.

**Minimum Requirements:** Projects are selected based on ranking the criterion which include but are not limited to the following: public fishing demand, accessibility, location, game fish present, and project sponsor donation.

**Program Funding:** Up to 100 percent of development and installation of the fishing pier/shoreland site with a maximum grant amount of \$25,000.00 for a traditional DNR floating fishing pier.

### **Water Recreation Cooperative Acquisition and Development Program**

**Program Purpose:** To improve public boat accesses to Minnesota's public lakes and rivers.

**Eligible Projects:** Acquisition, development and improvement of public boat accesses, parking lots, docks, and boat launching ramps. Engineering and design assistance is available.

**Minimum Requirements:** Projects are selected based on ranking the criterion which includes but is not limited to the following: public demand, location, game fish present, size of water body, accessibility, and sponsor donation.

**Level of Assistance:** The level of grant and technical assistance fluctuates considerably depending on the project scope, sponsor's need, and program's level of funding.

### **Community Education**

An important aspect of park and trail development is user knowledge of the recreational facilities. To promote the use of the community recreational system, the City should provide informational material to residents as the facilities are implemented. This information could be conveyed on the City's web site, a newsletter and map mailed to each household, or an article in a local newspaper. At the same time, the City should work to establish a list of rules and encourage community awareness of such.

### **Public Participation**

The development or improvement of parks and trails in the City is an excellent way to energize and direct the resource and talents of community volunteers, who are becoming more important in the delivery of quality leisure services. This approach can result in higher quality recreation opportunities at a more reasonable cost to the taxpayer. Under this scenario, it is essential that the City organize projects and cooperate with the volunteers of non-profit, private, industrial, commercial, or religious groups in the planning, financing, maintenance, and scheduling of projects.

### Identification and Signage

A clear, consistent, and concise system of park and trail signage is beneficial in any recreational system to assist users in finding and using the facilities. Many times signage is also beneficial when installed to identify future park or trail improvements as a means of informing prospective owners of adjacent/nearby property and for general public knowledge to let citizens know of work on progress. Most commonly associated with existing facilities, directional graphics may be in the form of painted pavement symbols, lettering or any variety of regulatory, warning, or guidance signage. Signage should include general identification of an area, layout and types of facilities present, directions for specific points of interest such as handicapped areas, restrooms, or connections to destinations, trail distances, and user/safety rules. The best location for much of this information is near the entrances to parks/trail segments or near parking areas. The signage should be consistent throughout the City and should be easily understandable and maintainable. The U.S. Department of Transportation's Federal Highway Administration has outlined size, shape, and color criteria for signs in the Manual of Uniform Traffic Control Devices (MUTCD).



# Facility Design Standards

## Introduction

Once a community has adopted a trail plan and secured easements for trail corridors, the next step in implementation is construction. The information that follows is intended to serve as a guide to the City of St. Francis in determining the location of trails within easements or along roadways and how the trails will be constructed. Issues such as locations of trails, slopes, intersections, disability accessibility and actual width and surfaces for trails will need to be addressed with any new trail. While the information provided may not address every situation, it will provide the general guidelines to assist the City in developing its trail system.

## Trail Guidelines

### Location of Trail

The location of the trail will need to be the first consideration in planning a corridor route. Those trails along a County highway will be planned within the existing right-of-way whenever possible. The City will also attempt to accommodate new trails within existing City rights-of-way when there are no easements present for trail purposes. In new developments, the City has the opportunity to take an easement for trail purposes. This would be a 20-foot easement on one side of the 66-foot right-of-way.

### Adjacent Land Uses

Land uses (existing and proposed) adjacent to or directly abutting trail corridors should be evaluated to some degree relative to size, facilities, density, character and type of ownership. However, unless safety factors are an issue, the establishment through all land use types should be promoted. Opportunities for or constraints against trail development exist in all areas of the community and generally depend more upon individual situations. In some situations, safety hazards can be avoided through an installation of a fence or berm while still allowing trail access and connections.

The trail should be designed so as not to interfere with access to or maintenance of utilities. Special consideration should be given to vacant properties which adjoin trails as they may potentially provide opportunities for sitting/picnicking areas or landscaping. Vacant areas that remain privately owned provide excellent opportunities for additional trail links, accesses or other trail-related development.

### **Adjacent Land Owners**

Of all the obstacles trail developers face, opposition by adjacent landowners can be the most troublesome. Regardless of community-wide support for trails, opposition from some adjacent landowners who will voice concerns about trails (i.e., trail design, management, quality of life, careless maintenance, land loss, decreased property value, increased crime and liability) will be unavoidable.

This and many other concerns have been documented among trail projects across the nation. Once the trail is open, however, the benefits usually far outweigh the problems. In surveys conducted nationwide, it has been shown that the vast majority of landowners living next to trail corridors were welcoming of them and used the trails frequently. With regards to crime, studies conducted in Minnesota showed that the incidence of crime is actually lower in homes near trails than those in surrounding neighborhoods. Furthermore, no negative effect upon property values has ever been proven, either nationally or locally, and in some cases neighborhoods adjacent to trail corridors have actually been marketed as an amenity in which case property values have increased.

### **Trail Width**

National standards for multi-use trail widths do not currently exist. The American Association of State Highway and Transportation Officials (AASHTO) recommends a ten foot trail width. Where “significant” trail traffic is anticipated (100 trail users per hour during peak periods), the width of a two-way shared path should be at least ten feet. In rural areas, with lesser trail traffic the minimum trail width is recommended to be eight feet.

*Additional facility design standards can be found in the Appendix at the end of this report.*

### **Park Accessibility – Americans With Disabilities Act<sup>1</sup>**

The Americans with Disabilities Act (ADA), which prohibits discrimination on the basis of disability, requires that newly constructed and altered state and local government facilities, places of public accommodation, and commercial facilities be readily accessible to, and usable by, individuals with disabilities. Recreational facilities, including play areas, are among the facilities required to comply with the ADA.

---

<sup>1</sup> Information from “Guide to ADA Accessibility Guidelines for Play Areas” prepared by U.S. Architectural Transportation Barriers Compliance Board, March 2001.

## Facility Design Standards

---

Generally, the ADA applies to newly designed and newly constructed play areas for children ages 2 and over. The ADA play area guidelines also apply to alterations made to existing play areas that affect, or could affect, the usability of the play area. Examples include removing a climbing play component and replacing it with a spring rocker, or changing the ground surfacing. Each play area within a site must comply with the ADA including. Play areas designed or constructed in phases must be coordinated to ensure that the entire play area complies with all the applicable provisions of the ADA when each successive addition is completed.

Individual play components must also be considered for compliance with the ADA. A play component is an element designed to generate specific opportunities for play, socialization, and learning. Different "types" of play components are based on the general experience provided by the play component and include, but are not limited to, experiences such as rocking, swinging, climbing, spinning, and sliding. The quantity of play components provided in a play area is determined by the type of play experience, not by the number of individuals who can play on a play component at once.

At least one of each type of play component provided at ground level in a play area must be on the accessible route. The number and variety of ground-level play components required to be on an accessible route is also determined by the number of elevated components provided in the play area. An "elevated play component" is a play component reached from above or below grade, and is part of a composite play structure. At least fifty percent (50%) of the elevated play components must be on an accessible route.

<b>Number of Elevated Play Components Provided</b>	<b>Minimum Number of Ground Level Play Components Required to be on Accessible Route</b>	<b>Minimum Number of Different Types of Ground Level Play Components Required to be on Accessible Route</b>
<b>1</b>	Not applicable	Not applicable
<b>2 to 4</b>	1	1
<b>5 to 7</b>	2	2
<b>8 to 10</b>	3	3
<b>11 to 13</b>	4	3
<b>14 to 16</b>	5	3
<b>17 to 19</b>	6	3
<b>20 to 22</b>	7	4
<b>23 to 25</b>	8	4
<b>More than 25</b>	8 plus 1 for each additional 3 over 25, or fraction thereof	5



## Facility Design Standards

---

The number of ground-level components determined by "one of each type" can also fulfill the minimum ground level requirement that is indicated by the elevated play components table.

The ADA guidelines should be consulted prior to: (1) altering portions of any existing play areas; or (2) implementing any newly designed and/or newly constructed play area for children ages 2 and over.

# Park Dedication Analysis

## Background

An evaluation of St. Francis's present dedication requirements for park and trails as a part of this Park and Trail Plan has been conducted. This information is intended to determine if St. Francis's present requirements are fair to developers and adequate for addressing the park needs of the community related to new development. The basis of this analysis is raw land costs and improvement costs related to the anticipated St. Francis Park and Trail System. This information will assist to determine the relationship of the City's existing dedication fees to actual land acquisition costs and illustrate how the fees should be adjusted, if necessary, to meet the City's park and trail needs. It must be emphasized that case law from the *Dolan v. Tigard* requires the City's dedication requirements be related to the benefit of the affected property. In this respect, the park dedication requirements must be based upon future park needs and their benefit to new subdivisions.

### Existing Dedication

Existing requirements for Park Dedication are outlined in Section 11-13-11 of the Subdivision Ordinance. According to the Subdivision Ordinance, in every plat, replat or subdivision, a reasonable portion of such land shall be set aside and dedicated by the owner or owners to the general public as open space for parks, playgrounds, trails, or public open space. The City last updated its park and trail dedication requirements in 2004, knowing that this figure may be altered based upon the forthcoming Park and Trail Plan. That update provided for a residential park dedication requirement of 10 percent of the gross area being subdivided or \$2,000.00 per unit cash fee in lieu of land. Industrial and commercial properties are required to dedicate 5 percent and 3 percent of the gross area being subdivided, respectively. For all residential and commercial/industrial dedications, it is the City Council's decision, with recommendation from the Park Commission and Planning and Zoning Commission, whether land, cash or a combination thereof will be accepted.

### Surrounding Jurisdictions

The following table illustrates 2004 park dedication fees for communities located in the northwest of the Twin Cities Metro Area. There is a significant difference between the communities' cash dedication fee in lieu of land, ranging from \$250 per dwelling unit to \$2,932 per dwelling unit for single family subdivisions. All but four of the surveyed communities require commercial and industrial developments to dedicate land for parks also.

## Park Dedication Analysis

<b>Park Dedication Fee Survey – July 2008</b>			
<b>City</b>	<b>Residential*</b>	<b>Commercial**</b>	<b>Industrial**</b>
Big Lake	\$2,500	N/A	N/A
Cambridge	\$1,600	\$2,940	\$2,940
Elk River	\$3,465	\$6,950	\$2,320
Elko-New Market	\$2,000	\$2,800	\$2,800
Isanti	\$1,500	\$1,500	\$1,500
Livonia Township	\$1,200	\$300	\$300
Montrose	\$1,600	\$3,000	\$2,000
Nowthen	\$2,000	\$2,000 per lot	\$2,000 per lot
Rockford	\$1,724	\$250	\$250
Zimmerman	\$2,500	\$2,500 per lot	\$2,500 per lot

\*per unit unless otherwise indicated  
 \*\*per acre unless otherwise indicated

### Land Costs

The following is an analysis of the costs of acquiring a parcel for a City park. The City would incur similar costs if it were to elect to accept fees in lieu of land and acquire park lands on its own. One option the City could use to determine park dedication fees in lieu of land is to pay a fee based upon the raw value of the property equal to the land dedication requirement. The benefit of this method is that the cash fee in lieu of land would be directly tied to the land acquisition costs, which would account for differences in land prices for various areas of the City and changes in land value over time. According to City officials, land costs within the City of St. Francis are currently around \$25,000 per acre for land within the MUSA and approximately \$15,000 per acre for rural land.

In order to determine the value of raw land, the developer would be required to disclose the purchase agreement for the property to define present market value. Other information that could be utilized includes Assessor's information, tax records and appraisals. Once the value of the property is established, the park dedication fee in lieu of land would be calculated based upon the following formula.

Estimated Raw Land Value/Acre		Required 10% Land Dedication		Per Acre Cash Dedication Fee in Lieu of Land
\$25,000	X	10%	=	\$2,500

## Park Dedication Analysis

According to the Comprehensive Plan, it is the City’s policy to extend and upgrade its sanitary sewer collection system in a manner consistent with the staged growth plan of the City. Additionally, the City plans to provide for a sanitary sewer system in any areas under consideration for annexation. As such, the value of raw land is assumed to be \$2,500 per acre for park dedication purposes. This figure represents a base amount and does not take into account the improvement costs for a park including, grading, landscaping and adding facilities and amenities.

The following analysis shows what the park dedication fee (in lieu of land) should be for raw land costs assessed per household. This figure takes into account the small and medium-sized parks as well as the additional community park (the proposed sports complex) that is planned for the City. Each new household is responsible for paying their fair share of these land acquisition costs, just as the existing households have by way of their previously paid park dedication fee in effect at the time they moved into the City.

Park Search Area	Acreage	No. of Proposed Parks	Total Acreage	Est. Land Value (\$25K/acre)	Divided by 2030 Households		Park Dedication Fee
Medium-Size Parks	< 25 acres	5	125 acres	\$3,125,000	5,000	=	\$625
Small-Size Parks	1-10 acres	9	90 acres	\$2,250,000	5,000	=	\$450
Community Parks/Sports Complex	60 acres	1	60 acres	\$1,500,000	5,000	=	\$300
					<b>Total</b>	<b>=</b>	<b>\$1,375</b>

The table outlines each new dwelling unit/households’ share of the land acquisition costs for the proposed medium, small and community parks identified in this Park and Trail System Plan. By taking the total land cost (\$25,000 per acre) and dividing that by the projected total number of households in 2030, when the City and the park system will have likely reached full build-out, is a total of \$1,375.

### Neighborhood Park Improvement Costs

Once the land has been purchased and/or dedicated for a park, additional costs are incurred for development and improvement of the park area. To determine an appropriate improvement cost for a typical neighborhood we have taken the average cost of previous and proposed improvements to existing and planned parks in the City. The average cost of improvements to a neighborhood park in the City of St. Francis is \$98,730.

In order to determine the necessary amount of the improvement costs for a neighborhood park that should be added to the park and trail development fee, we must take the total amount of neighborhood park improvements (\$98,730) and divide that by the estimated number of households who would benefit from this park, which would then be added to the park dedication fee assessed per dwelling unit for new developments. To get this estimated number of households, we take the typical required park acreage (10 acres/1,000 people) as discussed in earlier sections of the Park and Trail System Plan, which equates to approximately 100 people per acre of park land. We then take this figure of 100 people and divide that by the estimated number of people per household to get the number of households per park acre. The 2040 forecast for number of people per household is about 2.5, equaling just under 40 households per park acre. Therefore, improvement costs for a neighborhood park would ultimately cost each household approximately \$253.00 ( $\$98,730 / [39 \text{ households} \times 10 \text{ acres}]$ ). This \$253.00 cost per household would then be added to the park dedication fee for raw land determined to be \$1,375, for a subtotal of \$1,628.

The City of St. Francis already has approximately 7,300 residents and has 14 fully or partially developed parks. The park dedication fee must also take into account the park improvements that have already occurred within the City. Forthcoming park dedication fees from new developments will go towards development of new parks, however, in the case of a community park (such as a community sports complex) the acquisition and improvement costs of such a facility cannot be entirely paid for by new park dedication funds.

### Community Park Improvement Costs

Similar to the analysis for determining the percentage of park improvements to neighborhood parks that can be added to the park dedication fee; we figure that new residents would pay their fair share of proposed improvements to community parks, including the proposed full or half sports complex. It is important to note that existing residents have technically already contributed to the park fund, therefore any additional

## Park Dedication Analysis

funding that is necessary aside from park dedication fees must be provided from the City's general fund or from other sources.

Additional improvements to the City's existing Community Park were proposed to total \$244,861. Proposed improvement costs for the future full sports complex are determined to be a maximum of \$1,506,100.00 and estimated costs for a ½ sports complex are determined to be \$832,110.00.

<b>COMMUNITY PARK (WORK COMPLETED)</b>	
<b>FUTURE FACILITIES</b>	
<b>DESCRIPTION</b>	<b>TOTAL COST</b>
Playground with rock wall slides, tubes, overhead climbers	\$ 83,003.00
Concession building bathrooms refitting to create ADA stalls and additional urinals	\$ 3,000.00
Concession building (internal) Energy efficient lighting, external fans	\$ 2,152.00
Back stop hood and safety fence upgrade	\$ 8,400.00
Pave hockey rink	\$ 16,145.00
Basketball hoops installed in hockey rink	\$ 9,000.00
Pave back lot (40 cars) and drive	\$ 18,816.00
Pave front lot and drive	\$ 42,000.00
Pave 4,418 feet of assorted trails	\$ 54,184.00
Internal park lighting	\$ 8,161.00
	<b>\$ 244,861.00</b>

## Park Dedication Analysis

FUTURE PARK (FULL SPORTS COMPLEX)			
FUTURE FACILITIES			
QTY	DESCRIPTION	UNIT COST	TOTAL COST
			\$ 600,000.00 to
	LAND (40 - 60 acres, rural)	\$ 15,000.00	\$ 900,000.00
2	Hockey rink	\$ 27,000.00	\$ 54,000.00
1	Skating rink	\$ 5,000.00	\$ 5,000.00
	Lighting		\$ 10,000.00
1	Warming house w/ restrooms and storage	\$ 106,800.00	\$ 106,800.00
2	Baseball fields	\$ 43,750.00	\$ 87,500.00
6	Softball fields (little league)	\$ 5,000.00	\$ 30,000.00
6	Soccer fields with goals	\$ 5,000.00	\$ 30,000.00
4	Tennis courts	\$ 55,000.00	\$ 220,000.00
1	Play structure (super)		\$ 80,000.00
1	Shelter with concrete pad (large)	\$ 15,000.00	\$ 15,000.00
	¾ mile of trail	\$ 15.00	\$ 59,400.00
1	Concession stand	\$ 75,000.00	\$ 75,000.00
15	Picnic tables	\$ 400.00	\$ 6,000.00
14	bleachers	\$ 4,250.00	\$ 59,500.00
16	Players benches	\$ 275.00	\$ 4,400.00
12	park benches	\$ 800.00	\$ 9,600.00
	Parking area (paved - 200 stalls)	\$ 2,068.00	\$ 413,600.00
	Grading	\$3,000.00 per acre	\$ 120,000.00 to
	Irrigation		\$ 50,000.00
10	Trash receptacles	\$450.00	\$ 4,500.00
4	Bicycle racks	\$ 550.00	\$ 2,200.00
2	Drinking fountains	\$ 1,800.00	\$ 3,600.00
			<b>\$ 2,106,100.00</b> to
			<b>\$ 2,406,100.00</b>



## Park Dedication Analysis

FUTURE PARK (1/2 SPORTS COMPLEX)			
FUTURE FACILITIES			
QTY	DESCRIPTION	UNIT COST	TOTAL COST
	LAND (28 acres, Rural)	\$ 15,000.00	\$ 420,000.00
2	Hockey rink	\$ 27,000.00	\$ 54,000.00
1	Skating rink	\$ 5,000.00	\$ 5,000.00
	Lighting		
1	Warming house with restrooms and storage	\$ 106,800.00	\$ 106,800.00
3	Softball fields (little league)	\$ 5,000.00	\$ 15,000.00
	Lighting		
4	Soccer fields with goals	\$ 5,000.00	\$ 20,000.00
2	Tennis courts	\$ 55,000.00	\$ 110,000.00
1	Concession stand	\$ 75,000.00	\$ 75,000.00
10	Picnic tables	\$ 400.00	\$ 4,000.00
10	bleachers	\$ 4,250.00	\$ 42,500.00
10	Players benches	\$ 275.00	\$ 2,750.00
8	park benches	\$ 800.00	\$ 6,400.00
	Parking area (paved - 120 stalls)	\$ 2,068.00	\$ 248,160.00
	Park center building (two stories, septic system)		
	Irrigation		\$ 50,000.00
6	Trash receptacles	\$ 450.00	\$ 2,700.00
4	Bicycle racks	\$ 550.00	\$ 2,200.00
2	Drinking fountain	\$ 1,800.00	\$ 3,600.00
4	Hoops in hockey rink		
	Grading	\$ 3,000.00 per acre	\$ 84,000.00
			<b>\$ 1,252,110.00</b>

Assuming that everyone in the community would utilize the sports complex, we take the total number of households (2030 forecast) and divide that by the total improvement costs to determine the additional amount that could be added to the park dedication fee in order to cover the costs of building a sports complex (in addition to the cost of the land acquisition). For a full sports complex this figure would be \$301, for a ½ sports complex it would be approximately \$166 per household/dwelling unit. Additionally, new residents' share of park improvements to the existing community park is \$49 per dwelling unit.

## Park Dedication Analysis

---

We then must factor in the improvement costs for trails, since trails are an integral part of the park system and those costs should be included in the park dedication fees. Assuming that the land is included either as right-of-way for streets or as a part of the overall park land dedication percentages and/or fees, then the only additional costs that need to be factored in for trails are the cost of construction, labor and materials. The Parks Commission has estimated that the construction costs for future trail facilities would be \$2,303,316.80 which includes 22.92 miles of bituminous trail, a 300-foot elevated boardwalk and an 8-foot bridge. Thus, an additional \$460 per dwelling unit/lot would be necessary to pay for additional trail construction based on the projected 2030 population of the City.

### Recommendation

In summary, the park dedication fee is made up of cost of land acquisition and improvement costs. The chart below summarizes the estimated land acquisition/dedication and improvement costs discussed in the preceding section. Park dedication fees in lieu of land for the City of St. Francis, based on this analysis, should be \$2,285 to \$2,586 depending upon whether or not the City wants to plan for a full, half sports complex, or none at all.

Raw Land Cost	\$1,375
New Neighborhood Park Improvements	\$253
Existing Park Improvements (New Resident Share)	\$148
Community Park Improvements	\$49/\$166/\$301
Trail Construction	\$460
<b>Total (with full sports complex)</b>	<b>\$2,586</b>
<b>Total (with ½ sports complex)</b>	<b>\$2,451</b>
<b>Total (without sports complex)</b>	<b>\$2,285</b>

In comparison to other communities in the greater Twin Cities Metro Area and to the fact that St. Francis is a developing community, those park dedication fees are not unreasonable. The Park Commission should discuss whether or not they wish to include fees for the full sports complex, the half sports complex or neither and should provide direction City Staff regarding any amendment of the existing Subdivision Ordinance provisions. It is important to note that these park and dedication fees must be evaluated on an annual basis and will likely need to be adjusted at an amount correlating to the changes in costs of land, materials and construction costs.



## **Appendix A - Park Templates**

**Apparatus and Fields**

Americans with Disabilities Act Standards .....1  
Archery Range.....2  
Badminton .....3  
Combination Ballfield (Men’s and Women’s Softball and Youth Leagues) .....4  
Official Baseball Field .....5  
Little League Baseball Field.....6  
Basketball.....7  
Disc Golf .....8  
Field Hockey .....9  
Football/Soccer Field .....10  
Four Square.....11  
Golf Driving Range .....12  
Hopscotch.....13  
Horseshoes .....14  
Ice Hockey.....15  
Play structures.....16  
Informal Playfield .....17  
Shuffleboard .....18  
Soccer/Football Field .....19  
Tennis.....20  
Tetherball.....21  
Running Track .....22  
Volleyball .....23

**Trails**

Park Trail - Combination Pedestrian and Bicycle Trail.....24  
Transportation Trail – Combination Pedestrian and Bicycle Trail .....25  
Transportation Trail – “On Road” Bike Trail .....26

**Graphics & Specifications**

Architectural Graphic Standards, Seventh Addition, American Institute of Architects Robert T. Packard, AIA, New York, 1981.

The Americans with Disabilities Act (ADA), which prohibits discrimination on the basis of disability, requires that newly constructed and altered state and local government facilities, places of public accommodation, and commercial facilities be readily accessible to, and usable by, individuals with disabilities. Recreational facilities, including play areas, are among the facilities required to comply with the ADA.

Generally, the ADA applies to newly designed and newly constructed play areas for children ages 2 and over. The ADA play area guidelines also apply to alterations made to existing play areas that affect, or could affect, the usability of the play area. Examples include removing a climbing play component and replacing it with a spring rocker, or changing the ground surfacing. Each play area within a site must comply with the ADA including. Play areas designed or constructed in phases must be coordinated to ensure that the entire play area complies with all the applicable provisions of the ADA when each successive addition is completed.

Individual play components must also be considered for compliance with the ADA. A play component is an element designed to generate specific opportunities for play, socialization, and learning. Different "types" of play components are based on the general experience provided by the play component and include, but are not limited to, experiences such as rocking, swinging, climbing, spinning, and sliding. The quantity of play components provided in a play area is determined by the type of play experience, not by the number of individuals who can play on a play component at once. At least one of each type of play component provided at ground level in a play area must be on the accessible route. The number and variety of ground-level play components required to be on an accessible route is also determined by the number of elevated components provided in the play area. An "elevated play component" is a play component reached from above or below grade, and is part of a composite play structure. At least fifty percent (50%) of the elevated play components must be on an accessible route.

<b>Number of Elevated Play Components Provided</b>	<b>Minimum Number of Ground Level Play Components Required to be on Accessible Route</b>	<b>Minimum Number of Different Types of Ground Level Play Components Required to be on Accessible Route</b>
<b>1</b>	Not applicable	Not applicable
<b>2 to 4</b>	1	1
<b>5 to 7</b>	2	2
<b>8 to 10</b>	3	3
<b>11 to 13</b>	4	3
<b>14 to 16</b>	5	3
<b>17 to 19</b>	6	3
<b>20 to 22</b>	7	4
<b>23 to 25</b>	8	4
<b>More than 25</b>	8 plus 1 for each additional 3 over 25, or fraction thereof	5

The number of ground-level components determined by "one of each type" can also fulfill the minimum ground level requirement that is indicated by the elevated play components table.

The ADA guidelines should be consulted prior to (1) altering portions of any existing play areas or (2) implementing any newly designed and/or newly constructed play area for children ages 2 and over.

\* Information from "Guide to ADA Accessibility Guidelines for Play Areas" prepared by U.S. Architectural Transportation Barriers Compliance Board, March 2001.

ARCHERY RANGE

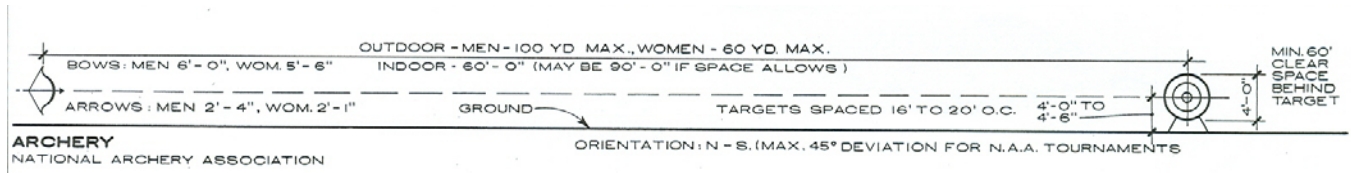

**Appropriate location:** Community Park/ Conservancy Lands and Open Space.

**Overall space requirements:** .65 to 1 acres

**Actual Size/Dimensions:** Shooting range should be 300' long and 10' wide minimum (15' preferred) between targets. Roped clear space behind targets should be 90' minimum and 30' minimum on each side of range.

**Preferred Orientation:** Range should be located so that the archer is facing north @ 45 degrees.

**Recommended surface gradient (%):** Constant side-to-side drainage pattern at 1.5 to 2.5 percent. Shooter and target should remain reasonably level.

**Parking:** Varies depending on specific site circumstances.

**General Construction Standards / Safety Issues:** The range should be located in an area that is not directly adjacent to or near other facilities or trails.

**General Remarks:** Site-specific safety considerations will dictate the actual location of the range.

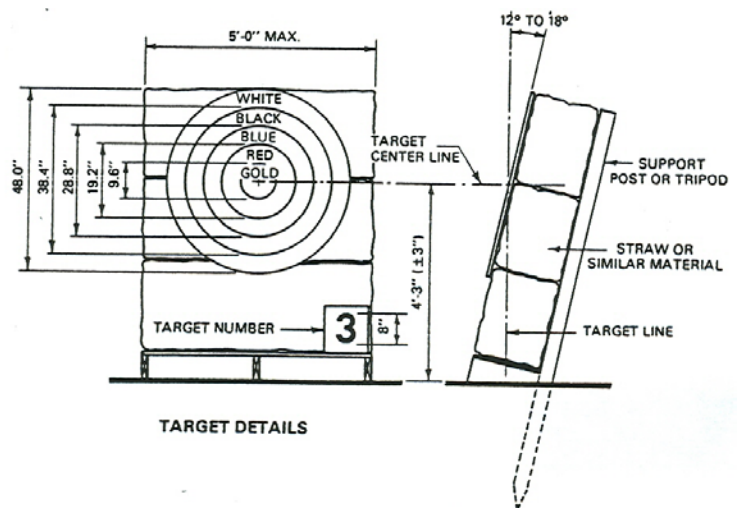

BADMINTON

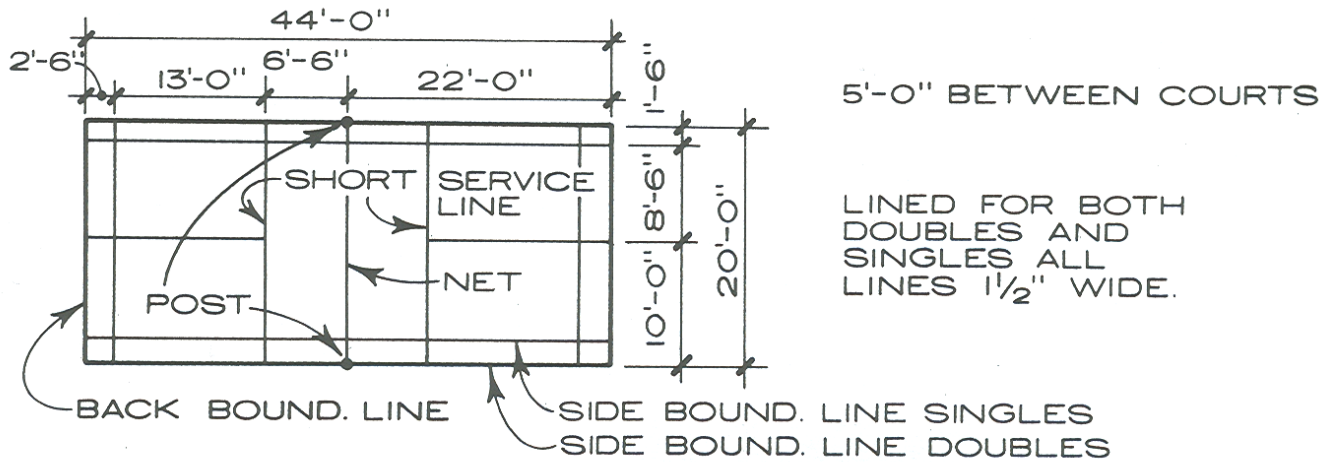

BADMINTON  
AMERICAN BADMINTON ASSOCIATION

**Appropriate location:** Community or Neighborhood Park, school, recreation center or church facility. Safe walking or biking access.

**Overall space requirements:** 1,620 sq. ft.

**Actual Size/Dimensions:** Singles 17' X 44' / Doubles 20' X 44' with 5' unobstructed area on all sides.

**Preferred Orientation:** Long axis north –south.

**Parking:** Varies depending on specific site circumstances.

**COMBINED BALL FIELD (MEN, WOMEN, SOFTBALL, YOUTH LEAGUE)**

**Appropriate location:** Community Playfield/Athletic Complex and school site

**Overall space requirements:** 2.0 to 2.5 acres per field minimum (very dependent on site drainage characteristics and safety zone requirements)

**Actual Size/Dimensions:** Baseline 60' to 75' // Pitching Distance 50'0" // The playing field radius is 300' from home plate (to accommodate men's softball) // An additional 30' of clear space (on same grade line) should be provided behind the outfield fence to allow for future changes in playing field size.

**Preferred Orientation:** Optimal orientation is to locate home plate so that the pitcher is throwing across the sun and the batter is not facing it. East-northeast recommended (home plate to center field).

**Recommended surface gradient (%):** Skinned baseline 1 to 1.25 (baseline and home plate should be level) // Outfield turf: 1.25 to 1.5

**Parking:** 50-60 cars per field minimum, with 60-65 being optimal. Additional parking may be required where spectators are expected.

**General Construction Standards / Safety Issues:** The baselines and the outfield warning track (10' wide) should be skinned using 6" min. depth of crushed red limestone specified for "ball diamond" use (add mixtures should be considered to promote long term stability and drainability). A foul-line warning track is desirable on principal-use fields. The infield should be sodded and the outfield seeded or sodded using an athletic field seed mix approved for this region. The backstop should be a minimum of 25' behind the home plate and adequate in size to control past and foul balls. An overhang or overhead net attached to the backstop should be considered in high pedestrian traffic areas. 6' high foul line and outfield fencing enclosing the entire field is preferable on principle-use fields. Players' benches should be fence enclosed to protect players from foul balls. All fencing/backstop should be centered on a 12"-18" wide concrete maintenance strip. An irrigation system should be considered a high-priority (including skinned infield/baseline). Bleachers and scoreboard should be provided on principle-use fields. Field lighting should be considered for principle use fields as well.

**General Remarks:** Site-specific circumstances and intended level of play are important considerations that will impact the actual design. Safety concerns (i.e. fence heights and locations, backstop size, etc.) should be carefully considered on a per site basis. The facility can be developed in phases (i.e. such as backstop and infield fencing/enclosed players benches in Phase I, with foul line and outfield fencing during Phase II, etc.) to coincide with the availability of funding.

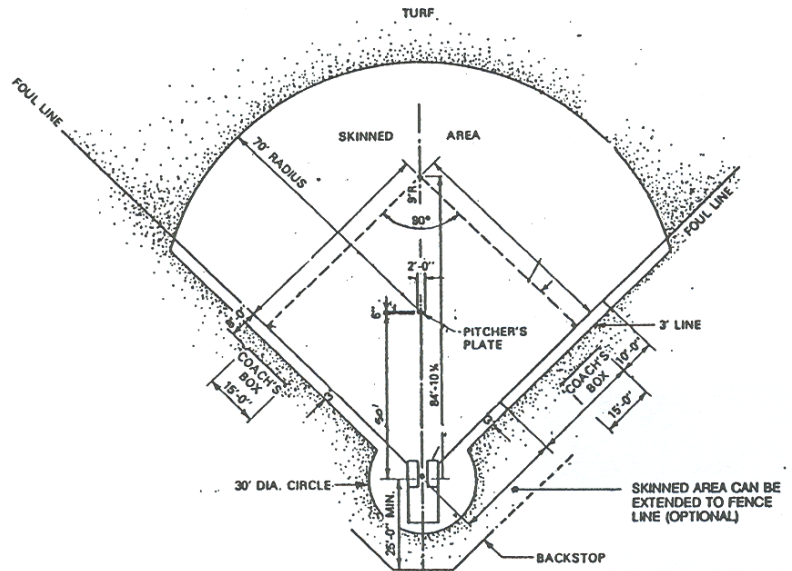



OFFICIAL BASEBALL FIELD

**Appropriate location:** Community Playfield/Athletic Complex and school site

**Overall space requirements:** 3.0 to 4.0 acres per field minimum (very dependent on site drainage characteristics and safety zone requirements)

**Actual Size/Dimensions:** Baseline 90' // Pitching Distance 60'6" // Pitcher's plate is 10" above home plate // Foul Line Distance: 320' minimum, 350' preferred // Centerfield Distance: 400'+

**Preferred Orientation:** Optimal orientation is to locate home plate so that the pitcher is throwing across the sun and the batter is not facing it. East-northeast recommended (home plate to center field).

**Recommended surface gradient (%):** Skinned baseline 1 to 1.25 (baseline and home plate should be level)

**Parking:** 30-40 cars per field minimum, with 50-60 being optimal. Additional parking may be required where spectators are expected.

**General Construction Standards / Safety Issues:** The baselines and the outfield warning track (10' wide) should be skinned using 6" min. depth of crushed red limestone specified for "ball diamond" use (add mixtures should be considered to promote long term stability and drainability). A foul-line warning track is desirable on principal-use fields. The infield should be sodded and the outfield seeded or sodded using an athletic field seed mix approved for this region. The backstop should be a minimum of 40' behind the home plate (60' preferred) and adequate in size to control past and foul balls. An overhang or overhead net attached to the backstop should be considered in high pedestrian traffic areas. 8' high foul line and outfield fencing enclosing the entire field is preferable on principle-use fields. Players' benches should be fence enclosed to protect players from foul balls. All fencing/backstop should be centered on a 12"-18" wide concrete maintenance strip. An irrigation system should be considered a high-priority (including skinned infield/baseline). Bleachers and scoreboard should be provided on principle-use fields. Field lighting should be considered for principle use fields as well.

**General Remarks:** Site-specific circumstances and intended level of play are important considerations that will impact the actual design. Safety concerns (i.e. fence heights and locations, backstop size, etc.) should be carefully considered on a per site basis. The facility can be developed in phases (i.e. such as backstop and infield fencing/enclosed players benches in Phase I, with foul line and outfield fencing during Phase II, etc.) to coincide with the availability of funding.

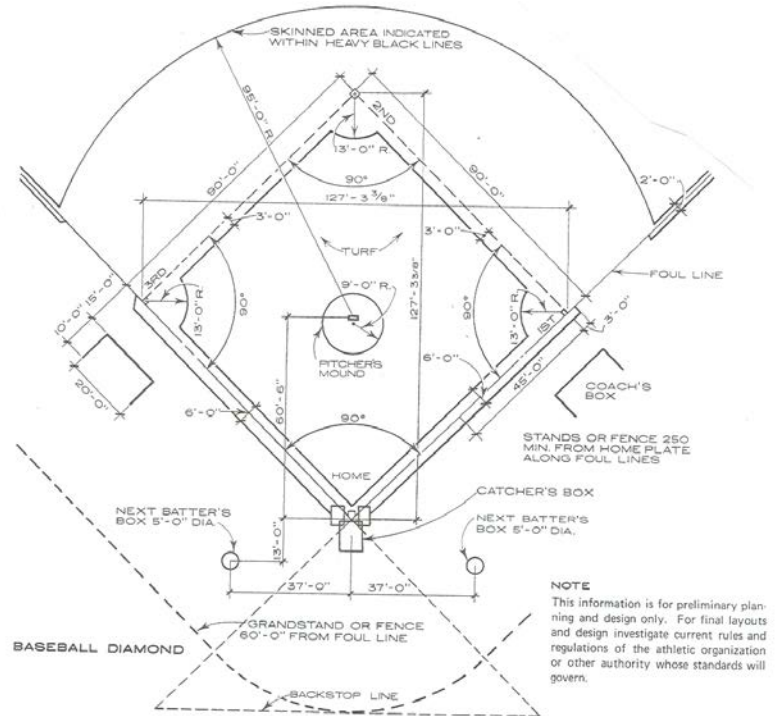

**LITTLE LEAGUE BASEBALL FIELD**

**Appropriate location:** Community Playfield/Athletic Complex and school site

**Overall space requirements:** 2.0 to 2.5 acres per field minimum (very dependent on site drainage characteristics and safety zone requirements)

**Actual Size/Dimensions:** Baseline 60' // Pitching Distance 46'0" // Pitcher's plate is 6" above home plate // Foul Line Distance: 225' to 235' preferred // Centerfield Distance: 250' optimal // An additional 30' of clear space (on same grade line) should be provided behind the outfield fence to allow for future changes in playing field size.

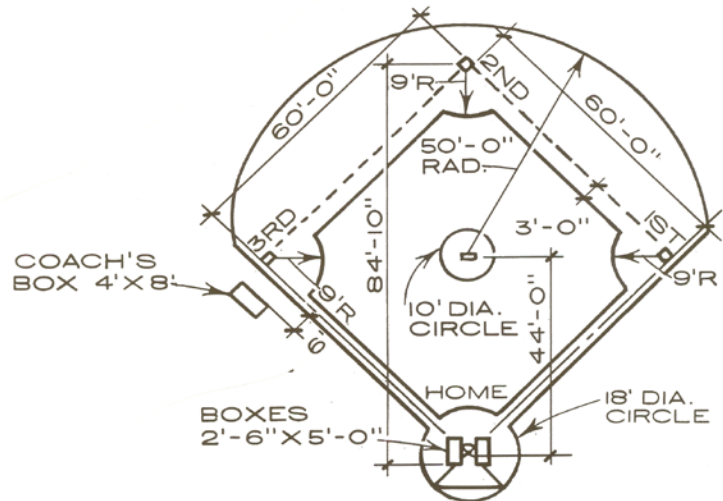

**Preferred Orientation:** Optimal orientation is to locate home plate so that the pitcher is throwing across the sun and the batter is not facing it. East-northeast recommended (home plate to center field).

**Recommended surface gradient (%):** Skinned baseline 1 to 1.25 (baseline and home plate should be level) // Infield turf: 1 to 1.25 // Outfield turf: 1.25 to 1.5

**Parking:** 30-40 cars per field minimum, with 50-60 being optimal. Additional parking may be required where spectators are expected.

**General Construction Standards / Safety Issues:** The baselines and the outfield warning track (10' wide) should be skinned using 6" min. depth of crushed red limestone specified for "ball diamond" use (add mixtures should be considered to promote long term stability and drainability). A foul-line warning track is desirable on principal-use fields. The infield should be sodded and the outfield seeded or sodded using an athletic field seed mix approved for this region. The backstop should be a minimum of 25' behind the home plate and adequate in size to control past and foul balls. An overhang or overhead net attached to the backstop should be considered in high pedestrian traffic areas. 6' high foul line and outfield fencing enclosing the entire field is preferable on principle-use fields. Players' benches should be fence enclosed to protect players from foul balls. All fencing/backstop should be centered on a 12"-18" wide concrete maintenance strip. An irrigation system should be considered a high-priority (including skinned infield/baseline). Bleachers and scoreboard should be provided on principle-use fields. Field lighting should be considered for principle use fields as well.

**General Remarks:** Site-specific circumstances and intended level of play are important considerations that will impact the actual design. Safety concerns (i.e. fence heights and locations, backstop size, etc.) should be carefully considered on a per site basis. The facility can be developed in phases (i.e. such as backstop and infield fencing/enclosed players benches in Phase I, with foul line and outfield fencing during Phase II, etc.) to coincide with the availability of funding.

BASKETBALL

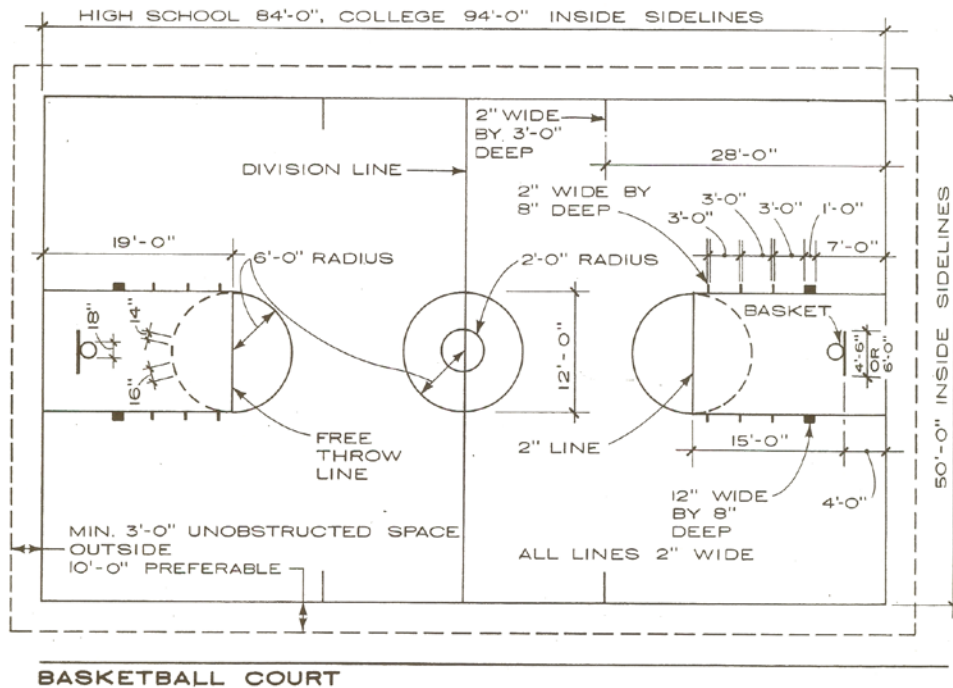

**Appropriate location:** Community Playfield/Athletic Complex, Community Park, Neighborhood Park and School Site.

**Overall space requirements:** 5,040 square feet minimum (7,280 square feet preferred)

**Actual Size/Dimensions:** Recommended court size is 50' X 84' plus 10' unobstructed space on all sides (3' minimum) // Half court size is 40' X 40'.

**Preferred Orientation:** Long axis north south.

**Recommended surface gradient (%):** 1.25 to 1.5 across asphalt surface.

**Parking:** Varies depending on specific site circumstances.

**General Construction Standards / Safety Issues:** Surface is typically asphalt laid over stable aggregate base. Basketball outfits should be of a manufactured variety with a heavy duty cantilevered post (5 9/16" o.d. – 4' to 6' overhang), fan shaped backboard, and twin-rim goal. Striping should be 2" wide plexicolor acrylic line paint approved for asphalt surfaces. Player's benches should be provided on each side of the court (minimum 5' from inbound line). Lighting should be provided on principle-use courts.

**General Remarks:** Color coat surfacing, available through a number of suppliers, can be used to add same color and greater definition to the playing surface. The basketball court can be part of a larger hard surface area (i.e. tennis court, hard surface games areas, etc.).

DISC GOLF

**Appropriate location:** Community Park

**Overall space requirements:** Ideally, 1 acre per hole, but can be considerably less depending on specific site circumstances.

**Actual Size/Dimensions:** Total course length should fall between 2,700' and 6,000', with at least two holes longer than 300' and no holes less than 90'.

**Preferred Orientation:** Varies depending on specific site. Ideally, north-south playing direction is preferred.

**Recommended surface gradient (%):** Ideally, varying topography with positive drainage away from tees and target area.

**Parking:** Varies depending on specific site circumstances. Ideally, 40 to 50 parking spaces should be available for users.

**General Construction Standards / Safety Issues:**

Generally speaking, disc golf is very similar to regular golf with the exception being that discs are used instead of clubs and balls. The ideal site would be one with a variety of terrain and vegetation in which the tees, fairways and target areas can be laid out in a logical fashion and where the playing lanes are clearly defined and interesting. "Amateur" tee locations should not exceed an average of 250' or 4,500' per 18 holes. "Pro" tees are up to 6,000' per 28 holes.

**General Remarks:** It is recommended that the City work with an established professional in the field who can assist in the design of the course.

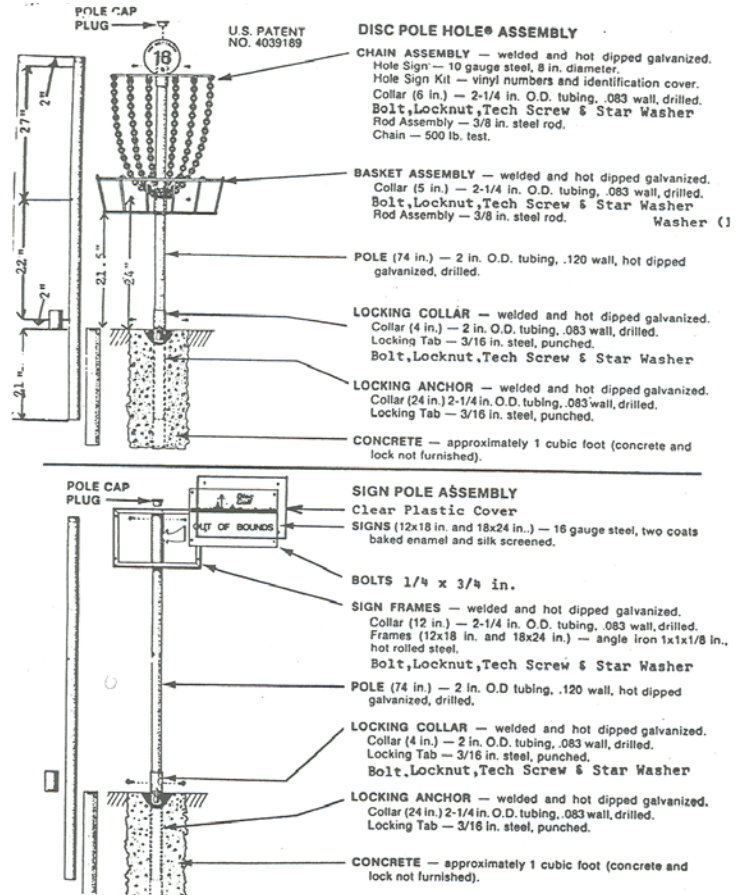

FIELD HOCKEY

**Appropriate location:** Community Playfield/Athletic Complex and school site

**Overall space requirements:** 1.5 to 2.0 acres per field minimum (very dependent on site drainage characteristics and safety zone requirements)

**Actual Size/Dimensions:** Playing field is 180' X 300' long plus an additional minimum of 10' unobstructed space on all sides.

**Preferred Orientation:** Long axis north-south orientation. Fall season: long axis northwest to southwest orientation.

**Recommended surface gradient (%):** 1.5 to 2.0 without under drainage // 1.25 to 1.5 with under drainage (preferred) // Drainage should be from center to each side (preferred) or side to side.

**Parking:** 35-40 cars per field minimum, with 40-45 being optimal. Additional parking may be required where spectators are expected.

**General Construction Standards / Safety Issues:** mix approved for this region. An irrigation system (infield/baseline). Preferred topsoil mixture (12' and 20% topsoil (screened and pulverized). Underdrainage system should be provided which should be of manufactured variety with a heavy on principle-use fields. Field lighting should be

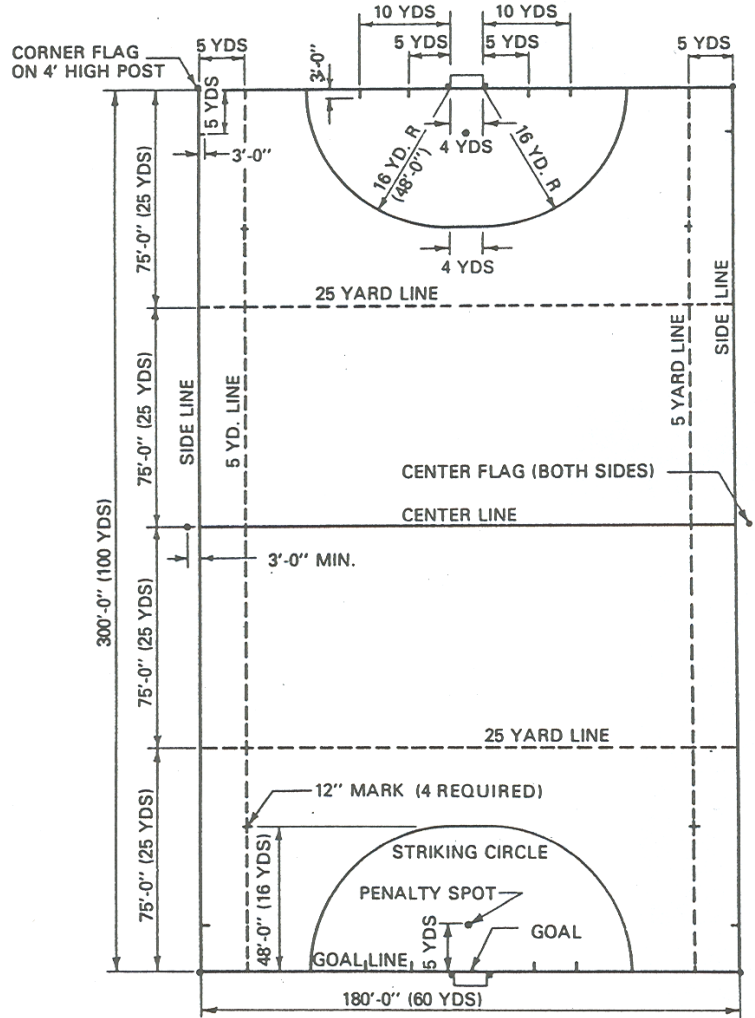

**General Remarks:** Site-specific circumstances and intended level of play are important considerations that will impact the actual design. Field hockey can be overlaid on a soccer/football field if demand does not justify a separate facility.

**FOOTBALL / SOCCER FIELD**

**Appropriate location:** Community Playfield/Athletic Complex and school site.

**Overall space requirements:** 2.0 to 2.5 acres per field minimum (very dependent on site drainage characteristics and safety zone requirements)

**Actual Size/Dimensions:** Soccer playing field is 195' to 225' wide (220' preferred) and 330' to 360' long (360' preferred) plus an additional minimum of 10' unobstructed space on all sides. Football field is overlaid on soccer field. Football field is 160' wide X 360' long with a minimum 6' of clearance on all sides.

**Preferred Orientation:** Long axis north-south orientation. Fall season: long axis northwest to southwest orientation.

**Recommended surface gradient (%):** 1.5 to 2.0 without under drainage // 1.25 to 1.5 with under drainage (preferred) // Drainage should be from center to each side (preferred) or side to side.

**Parking:** 30-40 cars per field minimum, with 40-45 being optimal. Additional parking may be required where spectators are expected.

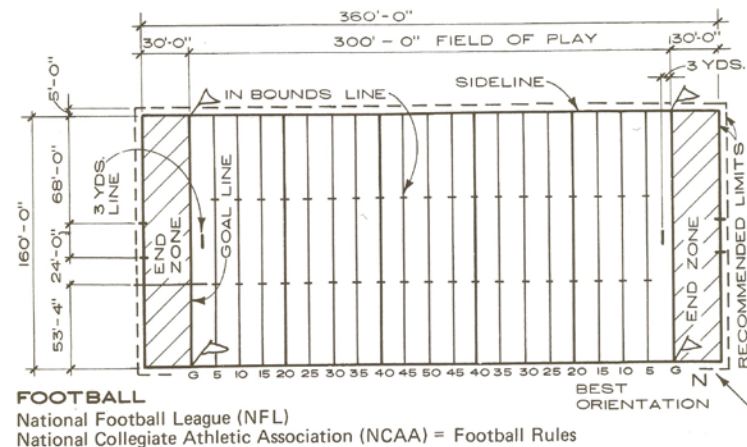
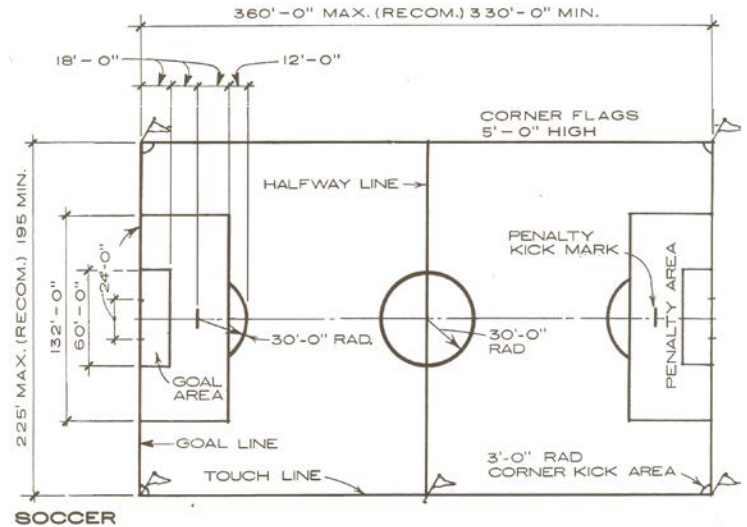

**General Construction Standards / Safety Issues:** The field should be seeded using an athletic field seed mix approved for this region. An irrigation system should be considered a high-priority (including skinned infield/baseline). Preferred topsoil mixture (12" minimum depth) should be 80% fine grade sand (low PH) and 20% topsoil (screened and pulverized). Alternate is 6" minimum screened and pulverized topsoil. Underdrainage system should be provided when sand based topsoil is used. Combination portable soccer/football goal should be of a manufactured variety with a heavy-duty frame. Bleachers and scoreboard should be provided on principle-use fields. Field lighting should be considered for principle use fields as well.

**General Remarks:** Site-specific circumstances and intended level of play are important considerations that will impact the actual design.

FOUR SQUARE

**Appropriate location:** Community Playfield/Athletic Complex, Community Park, Neighborhood Park and School Site.

**Overall space requirements:** 200 square feet minimum

**Actual Size/Dimensions:** Playing court size is 10' X 10' plus 4' unobstructed space on all sides (2' minimum).

**Preferred Orientation:** Optional.

**Recommended surface gradient (%):** 1.25 to 1.5 across asphalt surface // 1 to 1.5 across concrete surface

**Parking:** Not directly applicable.

**General Construction Standards / Safety Issues:**

Surface is typically asphalt laid over stable aggregate base. Striping should be 1½" wide plexicolor acrylic line paint approved for asphalt surfaces. Typically in combination with other hard court games.

**General Remarks:** Colorcoat surfacing, available through a number of suppliers, is often used to add some color and greater definition to the playing surface. Court is often in conjunction with other hard surface games.

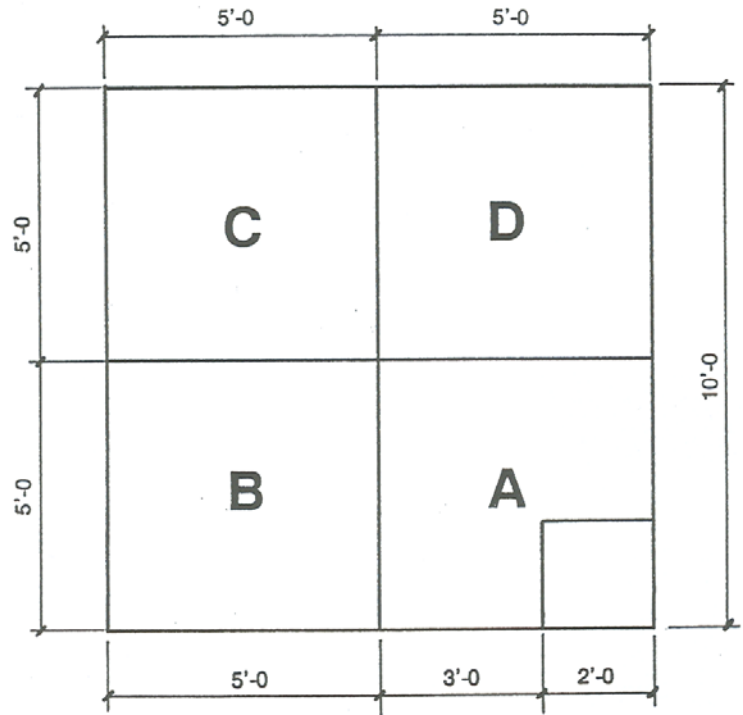

GOLF DRIVING RANGE

**Appropriate location:** Part of a golf course complex. As a separate unit, may be privately operated. May be a component of a sports complex or community park.

**Overall space requirements:** 13.5 acres for a minimum of 25 tees.

**Actual Size/Dimensions:** 900' long by 590' wide. Add 12' for each additional tee.

**Preferred Orientation:** Long axis southwest-northwest with golfer driving toward northeast.

**Parking:** Varies depending on specific site circumstances.

**General Remarks:** Facility should not be located more than 20 miles from the population center.

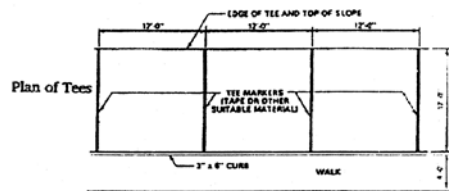
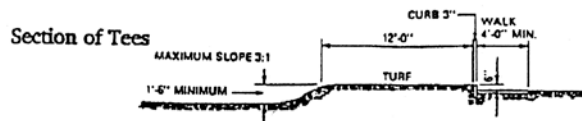



HOPSCOTCH

**Appropriate location:** Community Playfield/Athletic Complex, Community Park, Neighborhood Park and School Site.

**Overall space requirements:** 70 square feet minimum

**Actual Size/Dimensions:** Playing court size is 5' wide x 12'6" long plus 5' unobstructed space on all sides (3' minimum).

**Preferred Orientation:** Optional

**Recommended surface gradient (%):** 1.25 to 1.5 across surface // 1 to 1.5 across concrete surface

**Parking:** Not applicable.

**General Construction Standards / Safety Issues:** Surface is typically laid over stable aggregate base. Striping should be 1½" wide plexicolor acrylic line paint approved for asphalt surfaces. Typically in combination with other hard court games.

**General Remarks:** Color coat surfacing, available through a number of suppliers, is often used to add some color and greater definition to the playing surface. Court is often in conjunction with other hard surface games.

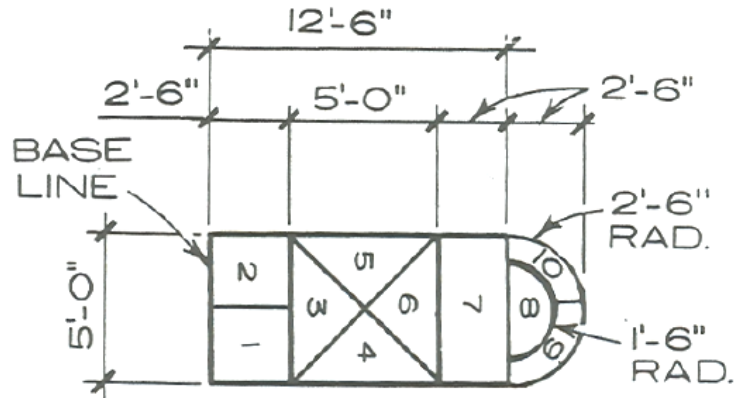

HOPSCOTCH

HORSESHOES

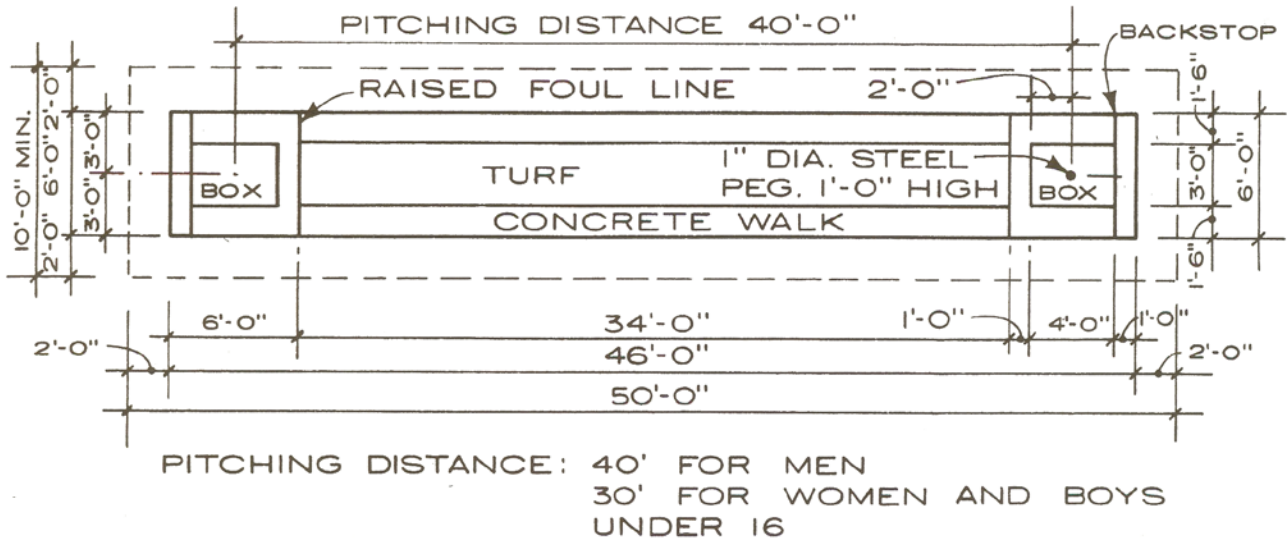

HORSESHOES

**Appropriate location:** Community Playfield/Athletic Complex, Community Park, Neighborhood Park and Open Space.

**Overall space requirements:** 1,400 square feet minimum

**Actual Size/Dimensions:** Playing court is a 10' wide x 50' long plus 10' minimum unobstructed space on all sides.

**Preferred Orientation:** Long axis north south.

**Recommended surface gradient (%):** 1 to 1.5 pitched to side.

**Parking:** Not directly applicable.

**General Construction Standards / Safety Issues:** Surface of playing area, except for boxes and optional walkways, should be turf. Boxes should be filled with potter's or blue clay. A 2' high backstop should be constructed on each end for safety purposes. Peg can be set in either concrete or solid oak block.

**General Remarks:** Adjacent pit should be no closer than 10' from stake to stake.

ICE HOCKEY

**Appropriate location:** Community Park, Sports Complex and School Site.

**Overall space requirements:** 22,000 square feet minimum

**Actual Size/Dimensions:** Playing rink is 85' wide by 200' long (minimum 85' X 185') plus an additional 5,000 square feet for support areas.

**Preferred Orientation:** Long axis north south.

**Recommended surface gradient (%):** Ice surface area should be level. Base should be sand-clay.

**Parking:** 20-30 cars per rink minimum. Additional parking may be required where an open skating rink is provided.

**General Construction Standards / Safety Issues:** The "boards" surrounding the rink should be 2" X 12" horizontal boards on the side and the ends and 2" X 6" vertical boards on the corner radii. Board height should be 46". Galvanized steel posts (3" min.) with concrete footing (or similar) should be used for support structure. Each end of the rink (from end to end of corner radii) should have a chain-link fence to a height of 4' above the boards to control pucks and protect spectators. A 10' wide access gate for maintenance and one to two 2' X 2'6" gate(s) should be provided for players. All gates must swing away from the ice surface. Bench areas can be provided on each side of the rink (optional). Boards should be painted white. Hockey goals should be of a manufactured variety and meet all applicable standards. Rink lighting should be provided.

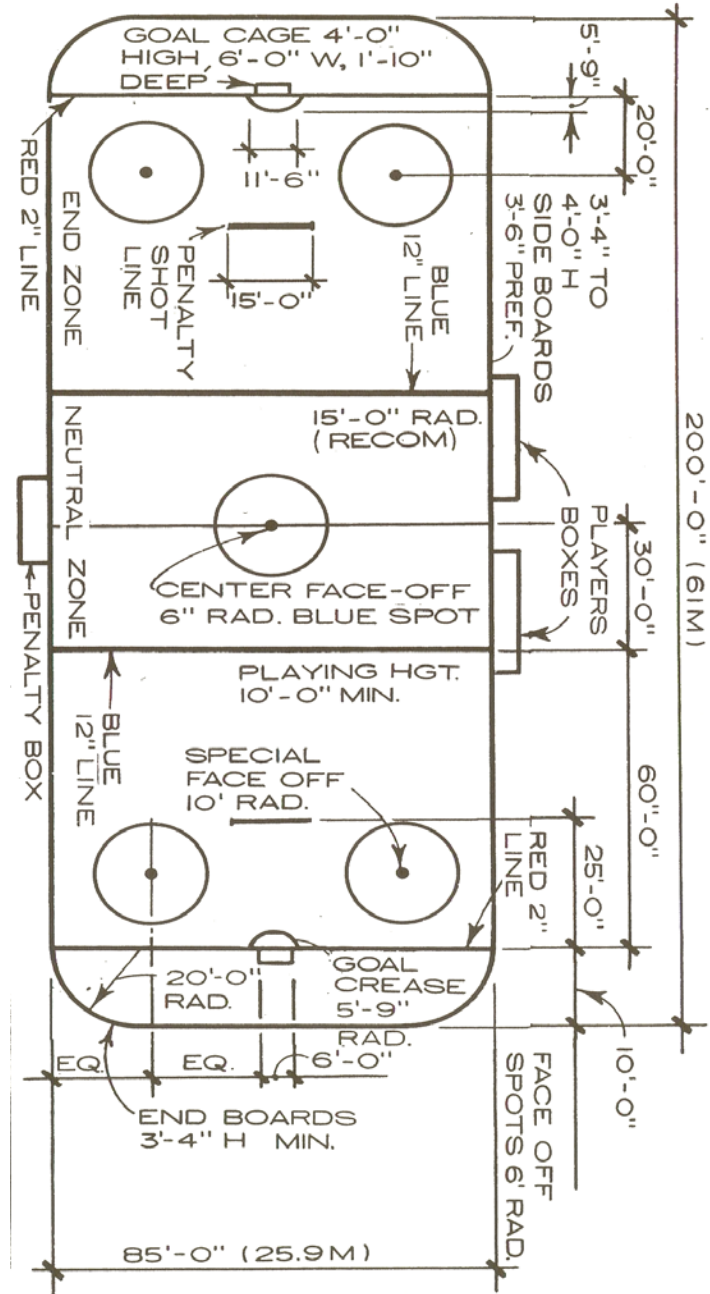

**General Remarks:** Ideally, rinks should be permanently built, structures where adequate park space is available. A warming house (permanent or portable) should be provided at each rink location.

**Graphics & Specifications**

Architectural Graphic Standards, Seventh Addition, American Institute of Architects Robert T. Packard, AIA, New York, 1981.  
Comprehensive Park Plan and Development Guide, City of Lino Lakes, Brauer & Associates, Ltd., 1991.

PLAY STRUCTURES

**Appropriate location:** Community Playfield/Athletic Complex, Community Park, Neighborhood Park and School Site.

**Overall space requirements:** 5,000 to 10,000 square feet

**Actual Size/Dimensions:** Varies depending on specific site circumstances. Typically 2,500 to 6,000 square feet on contained play area.

**Preferred Orientation:** Varies.

**Recommended surface gradient (%):** Subgrade in contained area should be 1.25 to 1.5. Underdrainage is typically required in non-drainable soils.

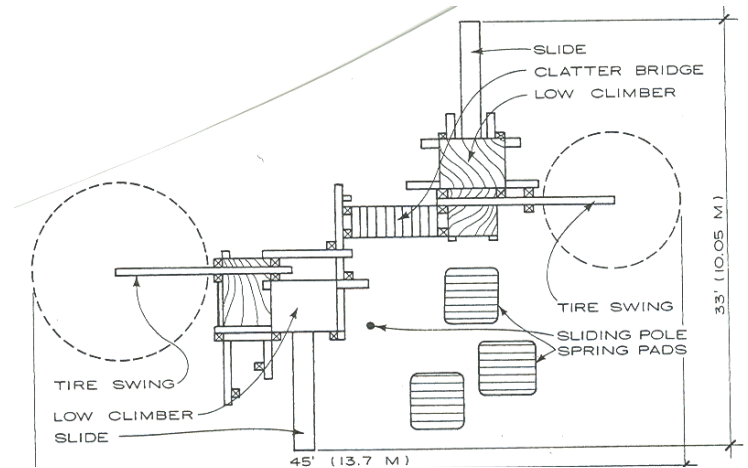

**Parking:** Varies depending on specific site circumstances.

**General Construction Standards / Safety Issues:**

First and foremost, all playground equipment should be of a manufactured variety. The manufacturer should be an established company with a proven history of safe and durable equipment (with at least a 10 year guarantee) and have the ability to work with a park designer to develop creative designs that are specific to a particular park. The design should be based on the continuous play concept that allows for continuous play within the play area by connecting large multi-level units with other active play components. Smaller, freestanding components (i.e. spring animals, sand scoopers, etc.) should also be provided to round out the play experience. Play areas should be designed to accommodate children from 3 to 10 years of age, with those from 3 to 5 years of age being the largest expected user group. The “play value” of the play equipment is also an important consideration. Each event (component) of the play equipment should provide either active play value (coordination, balance, and strength), creative play value (imagination), and social play value (group interaction/relationships). The manufacturer should be required to define the play value of a particular structure during the design process.

Site safety is an absolutely vital part of any play area and must be given due consideration during the design process. The manufacturer of equipment should be required to define the safety zone necessary to accommodate the proposed play equipment in a manner that meets or exceeds all accepted standards and provides a safe play environment. The surfacing material (such as 12” of sand) beneath the equipment must also meet safety standards. The container around the play areas is also important because it defines the play area, contains the surfacing material, and provides an important design element. A concrete curb (6” wide X 18” deep) is the preferred container material due to its long-term durability, ease of maintenance, and design characteristics.

**General Remarks:** Site-specific circumstances, design intent, anticipated user groups, and site safety considerations will dictate the design parameters for the play area.



SHUFFLEBOARD

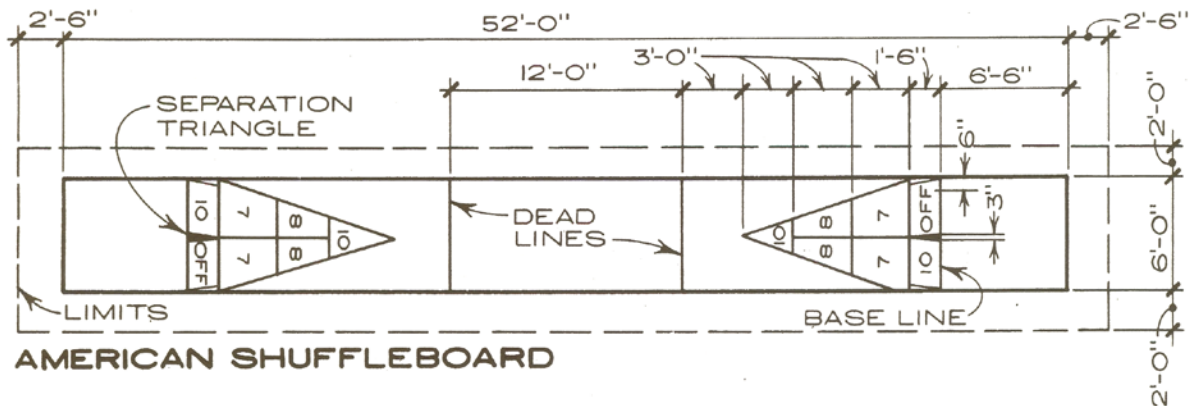

**Appropriate location:** Community Playfield/Athletic Complex, Community Park, Neighborhood Park and School Site.

**Overall space requirements:** 312 square feet minimum ground space

**Actual Size/Dimensions:** Playing court is 6' wide X 52' long plus a minimum of a 2' wide "alley" on each side (4' between courts in battery).

**Preferred Orientation:** Long axis north south.

**Recommended surface gradient (%):** Playing surface should be level; with drainage away from reach side of court.

**Parking:** Not directly applicable.

**General Construction Standards / Safety Issues:** Playing surface should be a concrete slab reinforced with wire mesh on compacted drainable subgrade. Concrete surface should be continuous, joint free with troweled finish. The "alley" on reach side of the playing court can be depressed 4" form the level of the actual playing surface (optional). The painted lines and number sand letters should be 1½" wide plexicolor acrylic line paint approved for concrete surfaces.

**General Remarks:** Shuffleboard courts should be located in an area where playing equipment is accessible to users.

**SOCCER / FOOTBALL FIELD**

**Appropriate location:** Community Playfield/Athletic Complex and school site.

**Overall space requirements:** 2.0 to 2.5 acres per field minimum (very dependent on site drainage characteristics and safety zone requirements)

**Actual Size/Dimensions:** Soccer playing field is 195' to 225' wide (220' preferred) and 330' to 360' long (360' preferred) plus an additional minimum of 10' unobstructed space on all sides. Football field is overlaid on soccer field. Football field is 160' wide X 360' long with a minimum 6 feet of clearance on all sides.

**Preferred Orientation:** Long axis north-south orientation. Fall season: long axis northwest to southwest orientation.

**Recommended surface gradient (%):** 1.5 to 2.0 without under drainage // 1.25 to 1.5 with under drainage (preferred) // Drainage should be from center to each side (preferred) or side to side.

**Parking:** 30-40 cars per field minimum, with 40-45 being optimal. Additional parking may be required where spectators are expected.

**General Construction Standards / Safety Issues:** The field should be seeded using an athletic field seed mix approved for this region. An irrigation system should be considered a high-priority (including skinned infield/baseline). Preferred topsoil mixture (12" minimum depth) should be 80% fine grade sand (low PH) and 20% topsoil (screened and pulverized). Alternate is 6" minimum screened and pulverized topsoil. Underdrainage system should be provided when sand based topsoil is used. Combination portable soccer/football goal should be of a manufactured variety with a heavy-duty frame. Bleachers and scoreboard should be provided on principle-use fields. Field lighting should be considered for principle use fields as well.

**General Remarks:** Site-specific circumstances and intended level of play are important considerations that will impact the actual design.

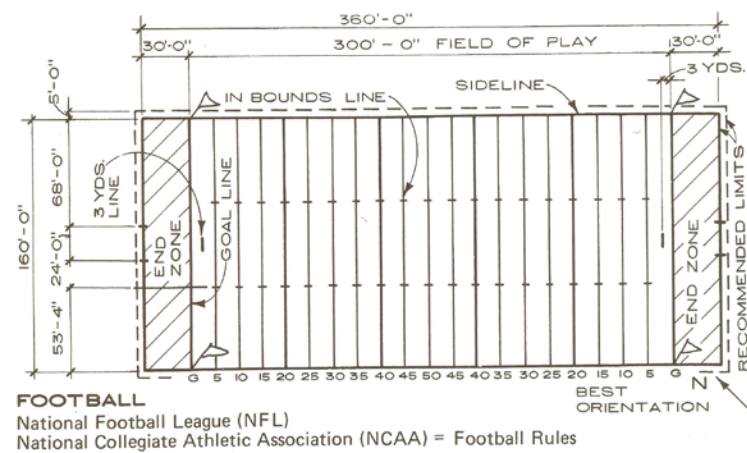
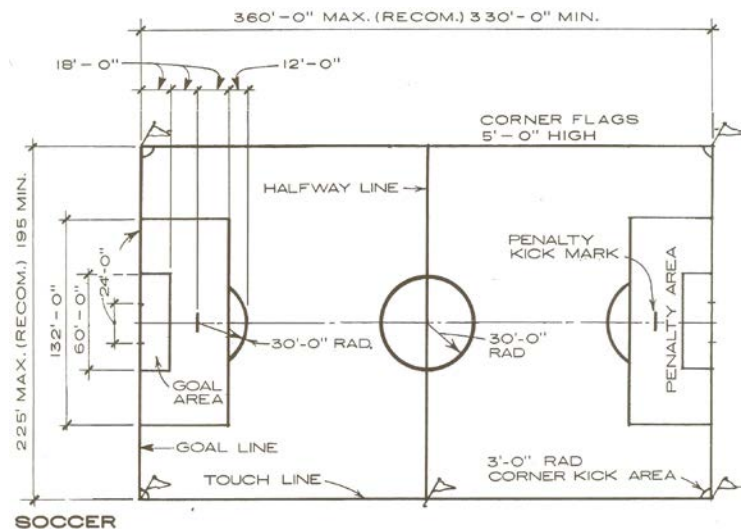

**FOOTBALL**  
National Football League (NFL)  
National Collegiate Athletic Association (NCAA) = Football Rules

TENNIS

**Appropriate location:** Community Playfield/Athletic Complex, Neighborhood Park and School Site.

**Overall space requirements:** 7,200 square feet minimum space for each court

**Actual Size/Dimensions:** Playing court is 36' wide X 78' long plus a minimum of a 12' clearance on both sides or between courts and 21' clearance on each end.

**Preferred Orientation:** Long axis north south.

**Recommended surface gradient (%):** 1.0 to 1.5 side to side preferred.

**Parking:** Varies depending on specific site circumstances.

**General Construction Standards / Safety Issues:** Surface should be asphalt laid over stable aggregate base. Tennis outfits should be of a heavy duty manufactured variety. Benches should be provided near the court for waiting players. Color coat surfacing, available through a number of suppliers, should be used to add color and definition to the playing surface. All court markings should be 2" wide. A 10' high chain link fence should surround the court area. If windscreen is to be used, fence should be constructed to handle increased wind loading. Fencing specifications should be verified against current industry standards at the time of construction. All fencing should be centered on a 12"-18" wide concrete maintenance strip. Lighting should be provided on principle-use courts.

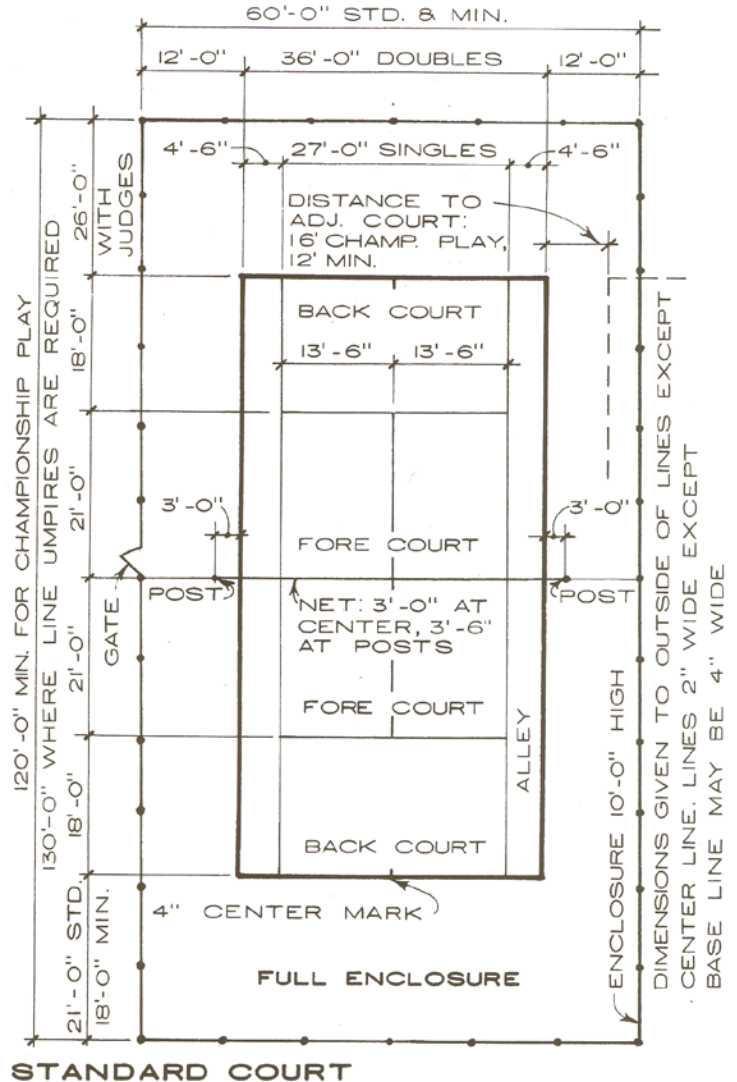

**General Remarks:** Tennis courts are typically in batteries of two or four. Tennis practice areas with a wooden tennis bounce wall are often constructed in combination with tennis courts in Community Playfields/Athletic Complexes.



TETHERBALL

**Appropriate location:** Community Playfield/Athletic Complex, Community Park, Neighborhood Park and School Site.

**Overall space requirements:** 314 square feet minimum to circumference of outer circle

**Actual Size/Dimensions:** Playing court is a 20' diameter circle. Pole height is 10'.

**Preferred Orientation:** Axis through playing zone is north south.

**Recommended surface gradient (%):** 1.25 to 1.5 across surface on any constant direction.

**Parking:** Not directly applicable.

**General Construction Standards / Safety Issues:** Surface can be asphalt or concrete laid over stable aggregate base. Striping should be 2" wide plexicolor acrylic line paint approved for asphalt and concrete surfaces. The pole should be a minimum 2 7/8" diameter steel.

**General Remarks:** Color coat surfacing, available through a number of suppliers, is often used to add some color and greater definition to the playing surface. Court is often in conjunction with other hard surface games.

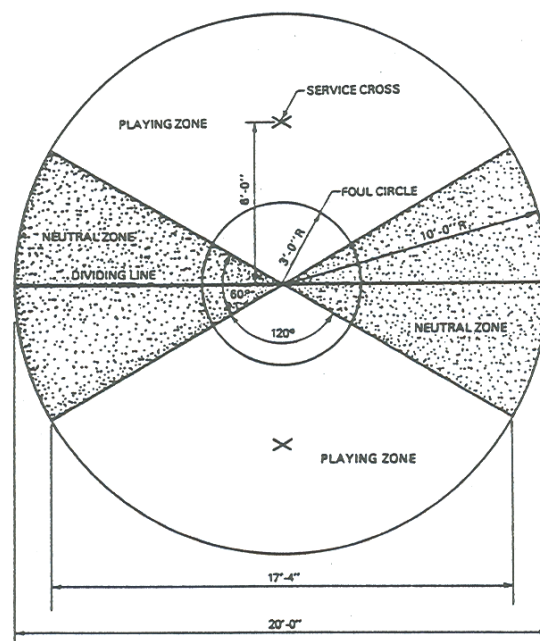
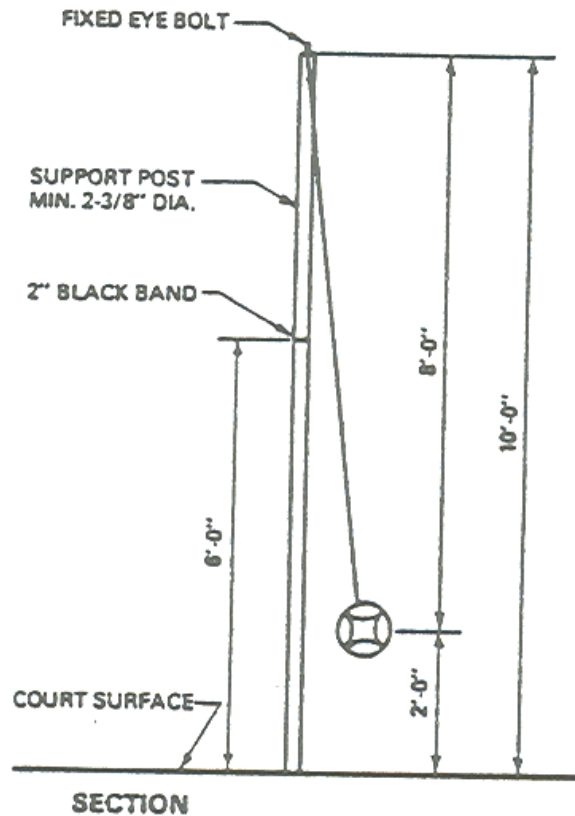



VOLLEYBALL

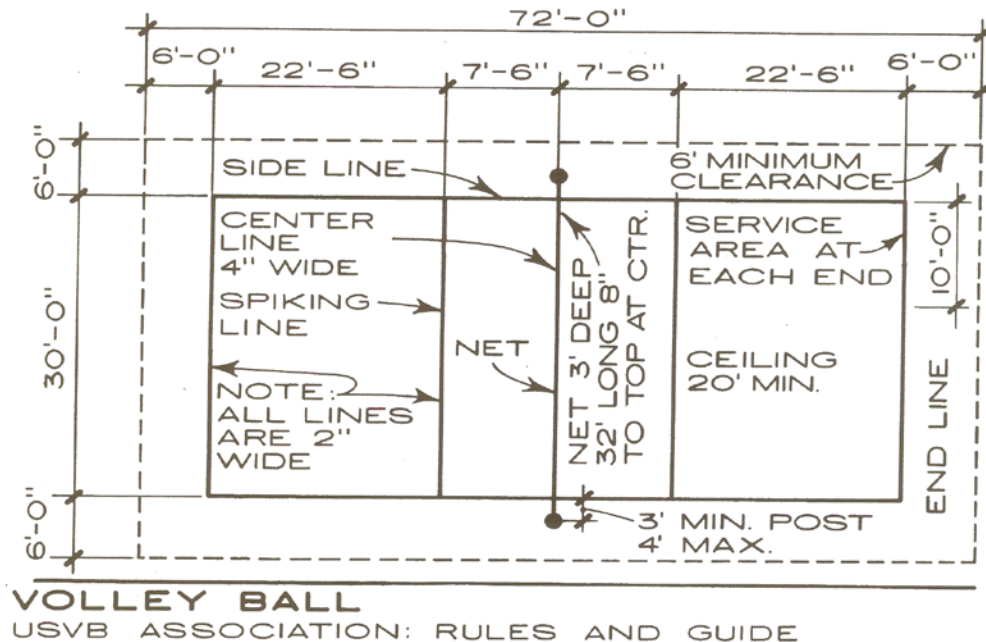

**Appropriate location:** Community Playfield/Athletic Complex, Community Park, Neighborhood Park and School Site.

**Overall space requirements:** 4,000 square feet minimum

**Actual Size/Dimensions:** Playing court is 30' X 60' plus 10' unobstructed space on all sides (6' minimum).

**Preferred Orientation:** Long axis north south.

**Recommended surface gradient (%):** 1.25 to 1.5 side to side with asphalt surface and 1.5 side to side for grass. Sand courts require under drainage.

**Parking:** Varies depending on specific site circumstances.

**General Construction Standards / Safety Issues:** Surface can be asphalt (when in combination with other hard court games), grass, or sand (preferred in high use areas such as community parks and athletic complexes). Striping should be 2" wide plexicolor acrylic line paint approved for asphalt on asphalt-surfaced court. Preferably, grass courts should have rubber corner and line markers (permanently set). Sand courts should have rope line markers with permanent anchors. The volleyball outfit should be of a heavy-duty manufactured variety with minimum 3" to 3½" steel posts.

**General Remarks:** Color coat surfacing, available through a number of suppliers, is often used to add some color and greater definition to the playing surface on asphalt courts. Sand courts are preferred due to their inherent safety (as compared to other surfaces).

**PARK TRAIL: COMBINATION PEDESTRIAN & BICYCLE TRAIL**

**Description:** Used for relatively uninterrupted pleasure hiking and biking through natural areas, greenways and parks.

**Standards:** Typically 8' minimum to 10' ideal width. Bituminous surface. Trail design including bridges, underpasses and crossings should follow applicable MnDOT design criteria.

**Trail Gradients:** 0 – 3% desirable. Maximum sustained grade of 8 to 10%. Maximum short distance grade of 15%.

**Sight Distance:** 50' minimum and 100' preferred.

**Signs:** Signage should be provided for all trail identification, maps/direction, information and regulation. All signage should be in accordance with MnDNR Sign Manual and MnDOT Manual on Uniform Traffic Control Devices.

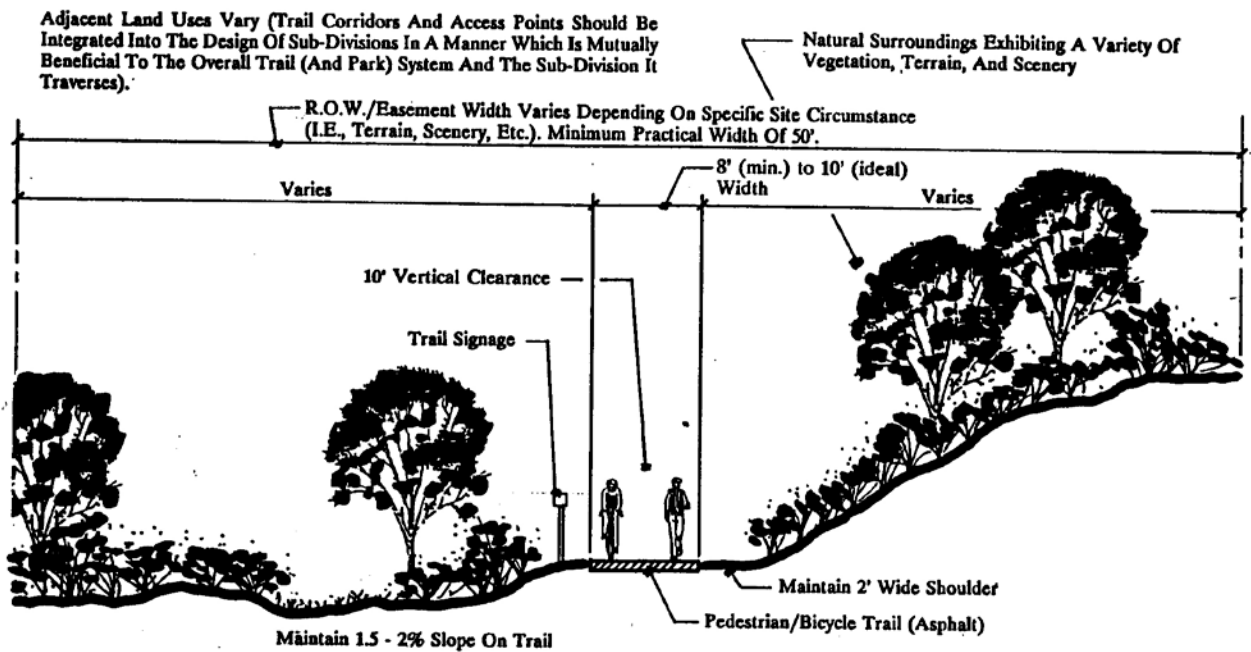

**TRANSPORTATION TRAIL: COMBINATION PEDESTRIAN & BICYCLE TRAIL**

**Description:** Used to provide safe travel for pedestrians and bicyclists to and from various parks as well as in and around the City. The trail separates users from vehicular traffic to increase safety for the users.

**Location:** Typically, but not exclusively, constructed along collector, minor and major arterial roads.

**Standards:** Typically 8' minimum to 10' ideal width. Bituminous surface. Trail design including bridges, underpasses and crossings should follow applicable MnDOT design criteria.

**Trail Gradients:** 0 – 3% desirable. Maximum sustained grade of 8 to 10%. Maximum short distance grade of 15%. In general, gradients should be similar to those of the adjacent road.

**Sight Distance:** 50' minimum and 100' preferred.

**Signs:** Signage should be provided for all trail identification, maps/direction, information and regulation. All signage should be in accordance with MnDNR Sign Manual and MnDOT Manual on Uniform Traffic Control Devices.

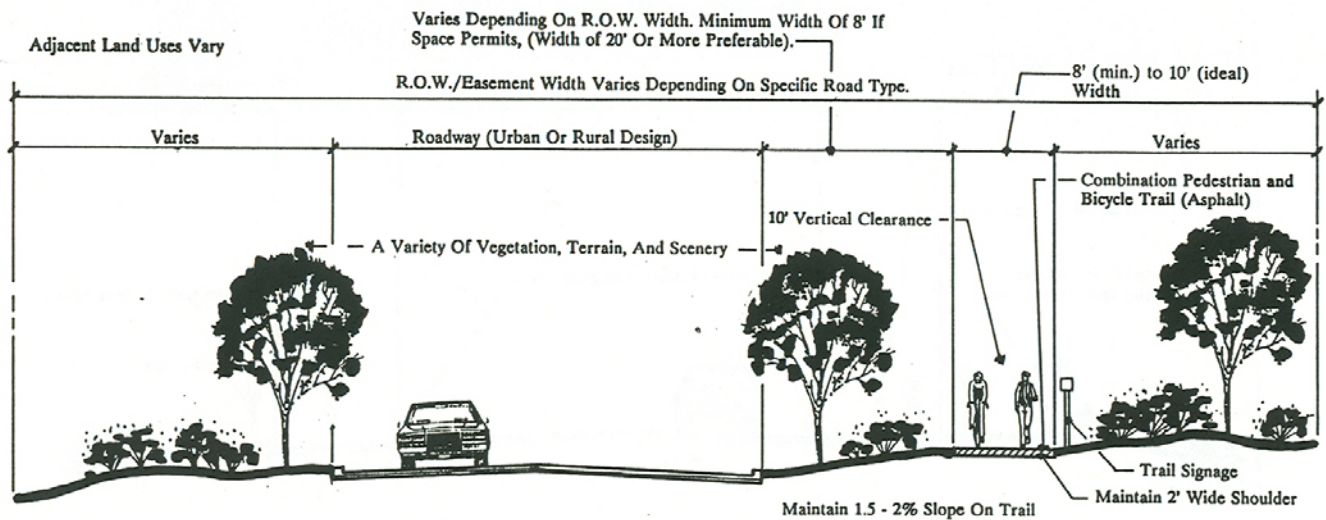

TRANSPORTATION TRAIL: "ON-ROAD" BIKE TRAIL

**Description:** Used to provide safe travel for bicyclists to and from various parks as well as in and around the City.

**Location:** Typically constructed along collector, minor and, on a limited bases, major arterial roads.

**Standards:** Typically 6' to 8' wide ideal (4' minimum). Bituminous surface. Bike route design including bridges, underpasses and crossings should follow applicable MnDOT design criteria.

Bike route (paved shoulder) is appropriate when bike lane is not feasible. Separate bike lane (designated traffic lane) is optimal in areas of heavy traffic.

**Trail Gradients:** Bike route gradients match that of the adjacent traffic lanes.

**Sight Distance:** As per vehicular traffic lanes.

**Signs:** Signage should be provided for all trail identification, maps/direction, information and regulation. All signage should be in accordance with MnDNR Sign Manual and MnDOT Manual on Uniform Traffic Control Devices.

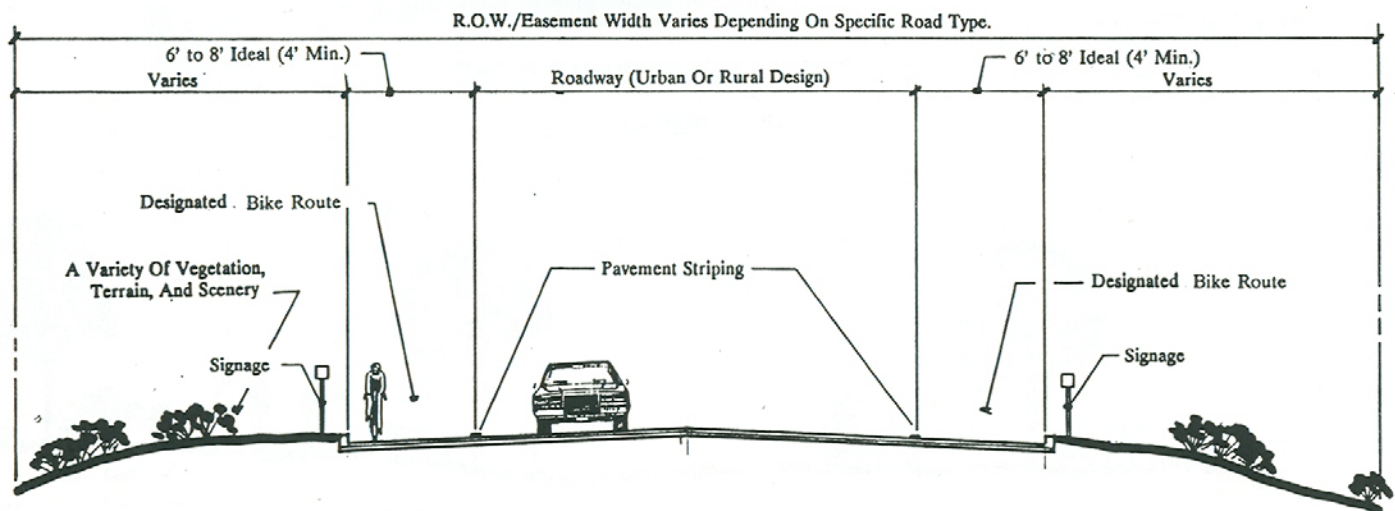



## **Appendix B – Recreational Facility Standards**

PG	ACTIVITY/FACILITY	RECOMMENDED SPACE REQUIREMENTS	RECOMMENDED SIZE AND DIMENSIONS	RECOMMENDED ORIENTATION	NUMBER OF UNITS PER POPULATION	SERVICE RADIUS	LOCATION NOTES
1	<b>ARCHERY RANGE</b>	Minimum 0.65 acres	300' length X minimum 10' wide between targets. Roped clear space on sides of range minimum of 30', clear space behind targets minimum of 90' X 45' with bunker	Archer facing north + or - 45°	1 per 50,000	30 minutes travel time	Part of a regional/metro park complex.
2	<b>BADMINTON</b>	1,620 sq. ft.	Singles 17' X 44' Doubles 20' X 44' with 5' unobstructed area on all sides	Long axis north-south	1 per 5,000	¼ to ½ mile	Usually in school, recreation center or church facility. Safe walking or biking access.
3	<b>BALL FIELD (COMBINED MEN, WOMEN, SOFTBALL, YOUTH LEAGUE)</b>	Minimum 2.0 to 2.5 acres	Baselines 90' Pitching distance 60+' Foul lines 320' minimum Center field 400+'	Locate home plate so pitcher throwing across sun and batter not facing it (east-northeast recommended)	1 per 5,000	¼ to ½ mile	Community playfield/athletic complex and school site.
4	<b>BASEBALL</b> ●official	Minimum 3.0 to 4.0 acres	Baselines 60'-70' Pitching distance 50' Home plate to playing field = 300' minimum	Locate home plate so pitcher throwing across sun and batter not facing it. Line from home plate through pitcher's mound running east-northeast.	1 per 5,000 Lighted 1 per 30,000	¼ to ½ mile	Part of neighborhood complex. Lighted fields part of community complex.
5	●little league	Minimum 1.2 acres	Baselines 60' Pitching distance 46' Foul lines 225'-235' Center field 200'-250'				



**Appendix B  
Recreation Facility Standards**

PG	ACTIVITY/FACILITY	RECOMMENDED SPACE REQUIREMENTS	RECOMMENDED SIZE AND DIMENSIONS	RECOMMENDED ORIENTATION	NUMBER OF UNITS PER POPULATION	SERVICE RADIUS	LOCATION NOTES
6	<b>BASKETBALL</b>						Usually in school, recreation center or church facility. Safe walking or biking access. Outdoor courts in neighborhood and community parks, plus active recreation areas in other park settings.
	●youth	2,400-3,036 sq. ft.	46'-50' X 84'*	Long axis north-south	1 per 5,000	¼ to ½ mile	
	●high school	5,040-7,280 sq. ft.	50' X 84'*	Long axis north-south	1 per 5,000	¼ to ½ mile	
	●collegiate	5,600-7,980 sq. ft.	50' X 94'*	Long axis north-south	1 per 5,000	¼ to ½ mile	
7	<b>DISC GOLF</b>	Minimum 1.0 acre	2,700' – 6,000' total course length w/ all holes longer than 90' and at least 2 holes longer than 300'	Ideally north-south			Community park.
8	<b>FIELD HOCKEY</b>	Minimum 1.5 acres	180' X 300' with a minimum 10' clearance on all sides	Fall season: long axis northwest to southwest For longer periods: long axis north to south	1 per 20,000	15 – 30 minutes travel time	Usually part of baseball, football, soccer complex in community park or adjacent to high school.
9	<b>FOOTBALL</b>	Minimum 1.5 acres	160' X 360' with a minimum 6' clearance on all sides	Fall season: long axis northwest to southwest For longer periods: long axis north to south	1 per 20,000	15 – 30 minutes travel time	Usually part of baseball, football, soccer complex in community park or adjacent to high school.
10	<b>FOUR SQUARE</b>	200 sq. ft. minimum	10' X 10' with a minimum 2' unobstructed space on all sides	Optional			Located in community playfield/ athletic complex neighborhood/ community park, mini park or adjacent to school site.
11	<b>GOLF DRIVING RANGE</b>	13.5 acres for a minimum of 25 tees	900' X 590' wide. Add 12' wide for each additional tee.	Long axis southwest-northwest w/ golfer driving northeast	1 per 50,000	30 minutes travel time	Part of golf course complex. As a separate unit, may be privately operated.

**Appendix B  
Recreation Facility Standards**

<b>PG</b>	<b>ACTIVITY/FACILITY</b>	<b>RECOMMENDED SPACE REQUIREMENTS</b>	<b>RECOMMENDED SIZE AND DIMENSIONS</b>	<b>RECOMMENDED ORIENTATION</b>	<b>NUMBER OF UNITS PER POPULATION</b>	<b>SERVICE RADIUS</b>	<b>LOCATION NOTES</b>
	<b>GOLF</b> ●par 3 (18 hole)	50-60 acres	Average length vary 600-2,700 yards	Majority of holes on north-south axis	--	½ to 1 hour travel time	Can accommodate 300-550 people/day. Course may be located in a community or district park, but should not be more than 20 miles from population center.
	●9 hole standard	Minimum 60 acres	Average length 2,250 yards	Majority of holes on north-south axis	1 per 25,000	½ to 1 hour travel time	Can accommodate 350 people/day. Course may be located in a community or district park, but should not be more than 20 miles from population center.
	●18 hole standard	Minimum 110 acres	Average length 6,500 yards	Majority of holes on north-south axis	1 per 50,000	½ to 1 hour travel time	Can accommodate 300-550 people/day. Course may be located in a community or district park, but should not be more than 20 miles from population center.
12	<b>HOPSCOTCH</b>	70 sq. ft. minimum	5' wide X 12'6" long plus 5' unobstructed space on all sides	Optional			Located in community playfield/athletic complex neighborhood/community park, mini park or adjacent to school site.
13	<b>HORSESHOES</b>	1,400 sq. ft. minimum	10' wide X 50' long w/ 10' unobstructed space on all sides	Long axis north-south			Located in community playfield/athletic complex neighborhood/community park, mini park or adjacent to school site.

**Appendix B  
Recreation Facility Standards**

<b>PG</b>	<b>ACTIVITY/FACILITY</b>	<b>RECOMMENDED SPACE REQUIREMENTS</b>	<b>RECOMMENDED SIZE AND DIMENSIONS</b>	<b>RECOMMENDED ORIENTATION</b>	<b>NUMBER OF UNITS PER POPULATION</b>	<b>SERVICE RADIUS</b>	<b>LOCATION NOTES</b>
14	<b>ICE HOCKEY</b>	22,000 sq. ft. including support area	Rink 85' X 200' (minimum 85' X 185') Additional 5,000 sq. ft. support areas	Long axis north-south if outdoor	Indoor: 1 per 100,000 Outdoor: depends on climate	1.2 to 1 hour travel time	Climate important consideration affecting number of units. Best as part of a multipurpose facility.
15	<b>PLAY STRUCTURES</b>	5,000 - 10,000 sq. ft.	6' wide X 52' long plus a minimum 2' alley on each side	Long axis north-south			Located in community playfield/athletic complex, neighborhood/community park, mini park or adjacent to school site. Playing equipment should be accessible to users.
	<b>MULTIPLE RECREATION COURT (BASKETBALL, VOLLEYBALL, TENNIS)</b>	9,840 sq. ft.	120' X 80'	Long axis of courts with primary uses north-south	1 per 10,000	1-2 miles	--
17	<b>SHUFFLEBOARD</b>	312 sq. ft. minimum ground space	Varies - Usually 2,500 – 6,000 sq. ft.	Varies			Located in community playfield/athletic complex, neighborhood/community park, mini park or adjacent to school site.
18	<b>SOCCER</b>	1.7 to 2.1 acres	195' to 225' X 330' to 360' with a 10' minimum clearance on all sides	Fall season: long axis northwest to southwest For longer periods: long axis north to south	1 per 10,000	1-2 miles	Number of units depends on popularity.

**Appendix B  
Recreation Facility Standards**

<b>PG</b>	<b>ACTIVITY/FACILITY</b>	<b>RECOMMENDED SPACE REQUIREMENTS</b>	<b>RECOMMENDED SIZE AND DIMENSIONS</b>	<b>RECOMMENDED ORIENTATION</b>	<b>NUMBER OF UNITS PER POPULATION</b>	<b>SERVICE RADIUS</b>	<b>LOCATION NOTES</b>
3	<b>SOFTBALL</b>	1.5 to 2.0 acres	Baselines – 60' Pitching distance – 46' minimum 40' – women Fast pitch field radius from plate – 225' Between foul lines slow pitch 275' (men) 260' (women)	Locate home plate so pitcher throwing across sun and batter not facing it. Line from home plate through pitcher's mound running east-northeast.	1 per 5,000 (if also use for youth baseball)	¼ to ½ mile	Slight difference in dimensions for 16" slow pitch. May also be used for youth baseball.
19	<b>TENNIS</b>	Minimum of 7,200 sq. ft. single court (2 acres for complex)	36' X 78' with 12' clearance on both sides & 21' clearance on each end	Long axis north-south	1 court per 2,000	¼ to ½ mile	Best in batteries of 2-4. Located in neighborhood/community park or adjacent to school site.
20	<b>TETHERBALL</b>	Minimum 314 sq. ft. circumference of outer circle	Playing court 20' diameter circle Pole height is 10'	Axis through playing zone is north-south			Located in community playfield/athletic complex, neighborhood/community park, mini park or adjacent to school site.
21	<b>RUNNING TRACK</b>	4.3 acres	Overall width 276' Length 600' Track width for 8 to 4 lanes is 32'	Long axis in sector from north to south to northwest-southeast with finish line at northerly end	1 per 20,000	15 to 30 minutes travel time	Usually part of high school, or in community park complex in combination with football, soccer, etc.

**Appendix B  
Recreation Facility Standards**

<b>PG</b>	<b>ACTIVITY/FACILITY</b>	<b>RECOMMENDED SPACE REQUIREMENTS</b>	<b>RECOMMENDED SIZE AND DIMENSIONS</b>	<b>RECOMMENDED ORIENTATION</b>	<b>NUMBER OF UNITS PER POPULATION</b>	<b>SERVICE RADIUS</b>	<b>LOCATION NOTES</b>
	<b>TRAILS</b>	N/A	Well-defined head maximum 10' width, maximum average grade 5% not to exceed 15%. Capacity rural trails – 40 hikers/day/mile. Urban trails 90 hikers/day/mile.	N/A	1 system per region	N/A	--
22	<b>VOLLEYBALL</b>	Minimum of 4,000 sq. ft.	30' X 60' with minimum 6' clearance in all sides	Long axis north-south	1 court per 5,000	¼ to ½ mile	Usually in school, recreation center or church facility. Safe walking or biking access. Outdoor courts in neighborhood and community parks, plus active recreation areas in other park settings.



## **Appendix C – Parks Capital Improvement Plan**

# Community Community Park

13 acres

St. Francis Community Park is about 13 acres in size, which is adequate for a community park. The park has a great location and good visibility. There are several overlapping service areas in this area but this is due to the river and Highway 47. Continued improvements to the City's sidewalk and trail system could bolster this park's use. The parking facilities allow for users from throughout the area to use this park.



## Amenities

- Playground equipment with rock wall wood edging and woodchip base (installed 2006) (\$56,000)
- Large parking lots (2006) (\$94,000)
- 4,400' of bituminous trails (\$58,000)
- Hockey Rink with Lights (\$89,000)
- Skating Rink (\$5,000)
- Warming House
- Softball field (\$5,000)
- Concession building/restroom (\$75,000)
- Volleyball court (\$4,000)
- Lighting (2006) (\$11,500)
- Picnic shelter
- 22 old wood picnic tables
- 5 grills
- Dumpster and Portapotty with wood screens
- Swing set
- Concrete curb added around play area

## Schedule

- 2015-2020 Upgrades needed to concession stand and restroom for usability and ADA compliance. (\$378,000)
- 2015-2020 Improve hockey rink, pave surface, replace boards, install basketball hoops. (\$135,000)
- 2020 Soil corrections, additional lighting along trails (\$25,000)
- 2031 Replace playground equipment (\$75,000)

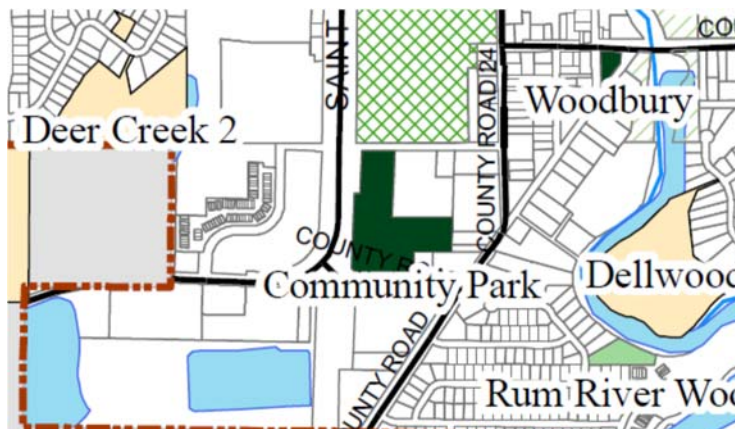

## Deer Creek Neighborhood Park

10.4 acres (mostly wetland)

The park in the Deer Creek subdivision is located near higher density housing and is attached to a large wetland. This makes the parcel about 11 acres in size but with only about a 3 acre area of it is upland. With some improvements to the trail or sidewalk system this park could be accessed by a greater number of users.



### Amenities

Play structure with climbing wall and swings  
wood chip base and wood edging (installed  
circa 2005) (\$42,000)  
Picnic shelter with cedar shakes (\$35,000)  
3 picnic tables & grill (\$1900)  
2 diggers in pea rock (\$620)  
Portapotty with wood screen  
2 park benches  
621' of bituminous trail (\$9000)  
1 trash can

### Schedule

2030 Replace play structure, picnic tables,  
benches (\$65,000)  
2030 Reroof picnic shelter





# Deer Creek Open Space

16.5 acres

Located on the southern edge of the City, this land was dedicated to be a future trail area around the wetlands. There is a strip of land between two houses providing access. With very limited access, it is unclear if this property could serve any other purpose.



## Amenities

Undeveloped

## Schedule

Trail (3180'), boardwalk (400'), and benches (5) discussed but not scheduled.

Trail Study needed to determine feasibility and potential locations

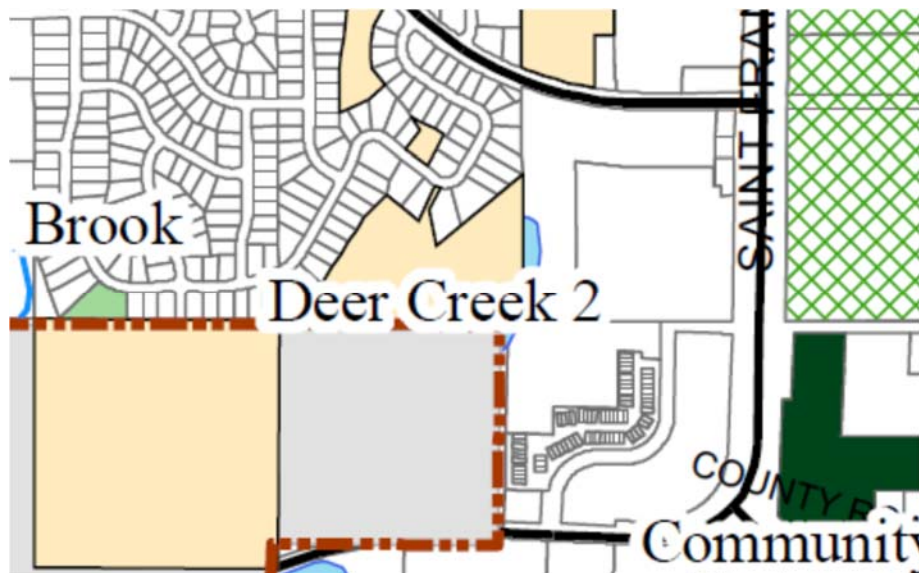

# DeGardner-Ambassador Square Neighborhood Park

1 acre

This park has very poor access, visibility, and had recently removed outdated equipment. It consists of 3 parcels that total about 1.3 acres. There are ponds located within the park that limits its usability. Outdated equipment can be a hazard and liability issue for the City. The potentially hazardous equipment has been removed but further study should be conducted on improving access prior to replacement. A sidewalk or trail connecting the park to the trail along Highway 47 may be an appropriate solution to establish an adequate service area. If there are no means to create better access to the park, perhaps a status change to a pedestrian corridor would be appropriate.

## Amenities

- Bituminous Trail (through park)
- Half basketball court (installed ca. 1990)
- Two slabs for picnic tables



## Schedule

2010 Replace play structure, resurface trail, resurface basketball court, add picnic tables, upgrade trash receptacle (\$55,000). (Hazardous equipment removed upon failing inspection, awaiting replacement upon future study)

At some point the park will need to be serviced with a trail system. Upgrading may need to be postponed until park has adequate connectivity or a more clearly defined usable service area.

Unclear ownership of southern portion of park near ponds. County records show private ownership. Investigation of this matter would necessary prior to future investment.

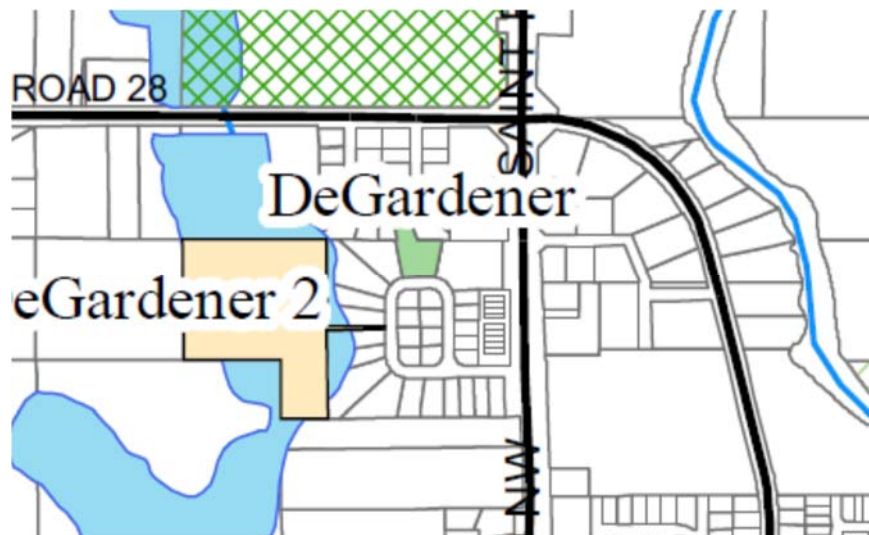

# Durigan Locher Neighborhood Park

1 acre

This park serves the area north of Bridge Street and east of Highway 47. The park is only about 1 acre in size and has limited accessibility, visibility, and connectivity. It could never be much more than a parcel housing play-ground equipment. There are limited areas available for expansion or replacement of this park. Further review of usability in conjunction with future development and possibility of connectivity improvements would be warranted.



## Amenities

Play structure with swing set (circa 2000) in pea rock with wood edging. ADD pad in rock for access.

189' Bituminous Trail

## Schedule

2015-20 Adding two park benches (\$1600), Upgrade trash can (\$400), Constructing an additional 400' of trail through the park. (\$8000)

2025 Replace play structure and upgrade surface (\$50,000)



# Hidden Ponds Neighborhood Park

8 acres

The park on Roanoke in the Hidden Ponds development is about 8 acres in size, has a parking lot, playground, and a ball field. Ideally, parks for ball field purposes would be larger in size. The property across the street has been discussed as a possible sports complex. If that were to be the case, this park could be incorporated into it, if it could be done in a safe manner. It is located near future development areas and could be used independently as a neighborhood park, as well. The park has excellent visibility, usability, and accessibility.



## Amenities

- Play structure and swing set (circa 2002) (\$35,000)
- 630' of Bituminous Trail (\$8200)
- 2 blue plastic barrel trash cans tied to sticks
- Parking lot
- Baseball diamond with bleachers

## Schedule

- 2027 Replace play structure (\$50,000)
- Irrigation & Concrete Curbing around play equipment is a necessity
- Landscaping has been discussed but not scheduled.



# Highland Woods Neighborhood Park

1 acre



## Amenities

Kiosk (\$5000)  
Portapotty with wood screen  
Playstructure (circa 2002) (\$33,000)  
Trails 630' - (\$8200)  
2 trash cans  
1 bench  
1 grill  
3 picnic tables  
Picnic shelter (\$32,000)  
Swingset

Access via sidewalk on Ivywood

Concrete Curbing installed around play-ground equipment

## Schedule

Park boundaries have been disputed, a survey may be needed (\$2000)

Irrigation system needed

2027 Reroof picnic shelter

2027 Replace play structure, replace tables and benches. (\$55,000)



# Rum River Woods Neighborhood Park

2 acres

The park in the Rum River Woods development appears to be underdeveloped and also has some overlap with the service area for the Community Park. The park has river frontage and is 2 acres in size, which gives it some degree of potential. It is only approximately 75 feet wide in size which is not ideal for parkland but also limits its other potential uses. This park could use sidewalks or trails to increase its connectivity.



## Amenities

Play structure circa 1997 (\$18,000)  
50' trail  
River access

## Schedule

Irrigation, park benches, small shelter, bike rack, paved trail, river overlook, grill, tennis court discussed but not scheduled. Project would include replacement of play structure. (\$125,000)

Park boundaries need surveying (\$2000)

2020-25 Replace play structure

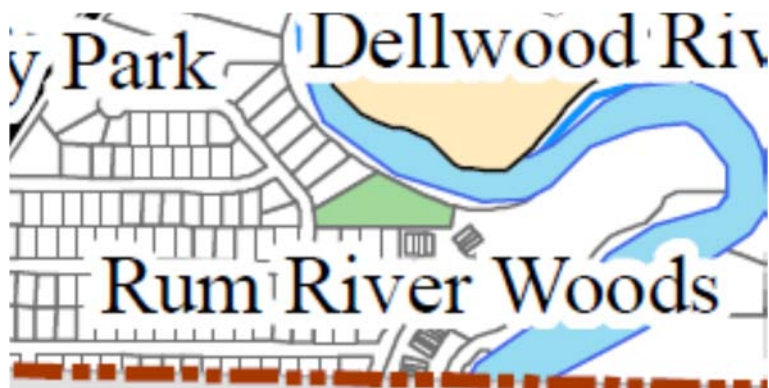

## Seelye Brook Neighborhood Park

1 acre

This park is a little over an acre in size and located on a local road. It is a gateway to the Wickstrom Forest Park in Oak Grove. There is limited visibility that can cause concerns in portions of this park. However, it appears to generally serve the purpose for which it was acquired and is providing a service in an area that would otherwise be difficult.



### Amenities

Sledding hill

Play structure with wood edge and wood-chips, climbing wall, 2 diggers, swings (\$55,000) installed circa 2006

Portapotty without shield

1 old picnic table no slab

175' of bituminous trail

### Schedule

2015-2020 Trash can and picnic table upgrades needed and Concrete Curbing around play equipment needed

2031 Park equipment replacement (\$60,000)

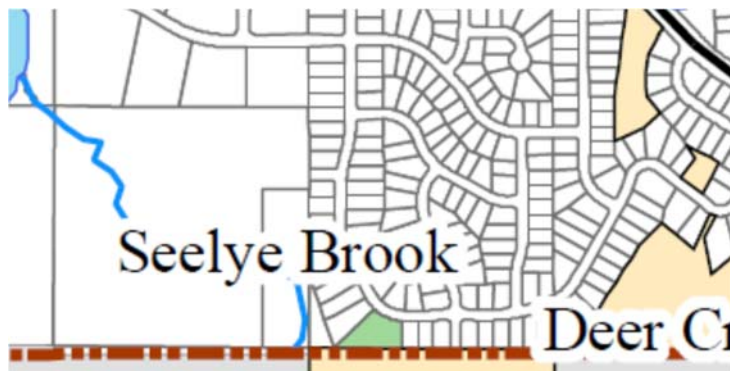

## Woodbury Special Use Park

Less than 1 acre



### Amenities

- Brick paver path (\$24,000)
- Perennials (\$6000)
- Gazebo (\$42,000)
- Memorial garden (\$38,000)
- Lighting (\$13,500)
- 10 Wrought iron benches (\$11,000)
- Drinking fountain (\$3000)
- Fountain (\$35,000)

### Schedule

- Wrought iron fence and gates, irrigation, tree replacement have been discussed
- Gazebo and trail need maintenance schedule
- The fountain was fixed in 2014

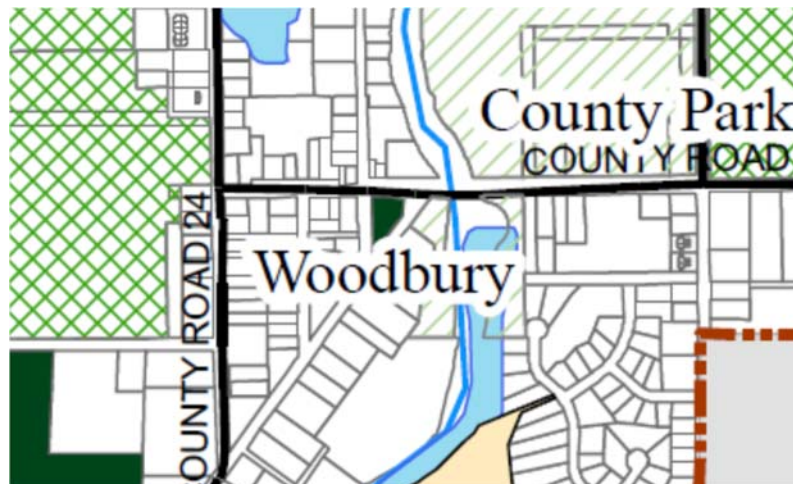



### Safety & Loss Control Planning

It is important for the City to ensure the park system is safe for park users. While a general good practice, it also helps to limit insurance claims and legal action against the City. There are expected maintenance schedules for park facilities and routine inspection programs to ensure each piece of equipment is in good working order and not a potential liability.

For example, the City follows this general schedule:

Playground Equipment	Replace after 20-25 years. Begin thorough safety inspections after 15 years. Routine maintenance may be necessary. New equipment is to be paid for out of Park Dedication Fund.
Trails	Seal coat and crack fill every 7-10 years depending on level of use. Plan for possible resurfacing after 20 years if inspections warrant.
Picnic Tables, Park Benches & Garbage Cans	Set uniform specs to have replacements available in response to damage. Regular inspections required. Plan for replacement after 20 years.
Sport Courts	Plan for resurface after 20 years. Regular crack filling and maintenance may be required.
Picnic Shelters	Routine inspections to determine maintenance schedule. Roof repairs anticipated for years 20-25.

### Future Funding Commitments

Park projects are presented in five year increments for budgeting purposes as part of the City's capital improvement planning. Related to the general schedules note above, the City monitors park projects on a longer term schedule, as well.

The following table depicts playground equipment replacement schedules. Within the next 15-20 years, the City will need to replace approximately \$445,000 of playground equipment. This does not include any other future installation or new parks that may be brought into the system with new development.

Year	Park	Est. Cost
2010	DeGardener-Ambassador Square (on hold)	\$55,000
2020	Rum River Woods	\$50,000
2025	Durigan-Locher	\$50,000
2027	Hidden Ponds	\$50,000
2027	Highland Woods	\$50,000
2030	Deer Creek	\$65,000
2031	Community	\$75,000
2031	Seelye Brook	\$60,000
	<b>Totals</b>	<b>\$455,000</b>

New development will bring in more money but may also bring in more land to the system that requires development. Upon new subdivision, the City will need to analyze the budgetary impact of future park development.

In the meantime, the City will need to ensure it has the requisite funds for equipment replacement in the park system. This may merit supplementing the Park Dedication Fund.